

BETTER HOMES & GARDENS 8-CUBE STORAGE ORGANIZER WITH 4 X INSERTS

VENDOR STOCK NUMBERS
BH5336278612067-WHITE TEXTURE
BH5336278612068-TOBACCO OAK

THIS PRODUCT MUST ALWAYS BE MOUNTED TO A WALL OR STUD FOR USE.

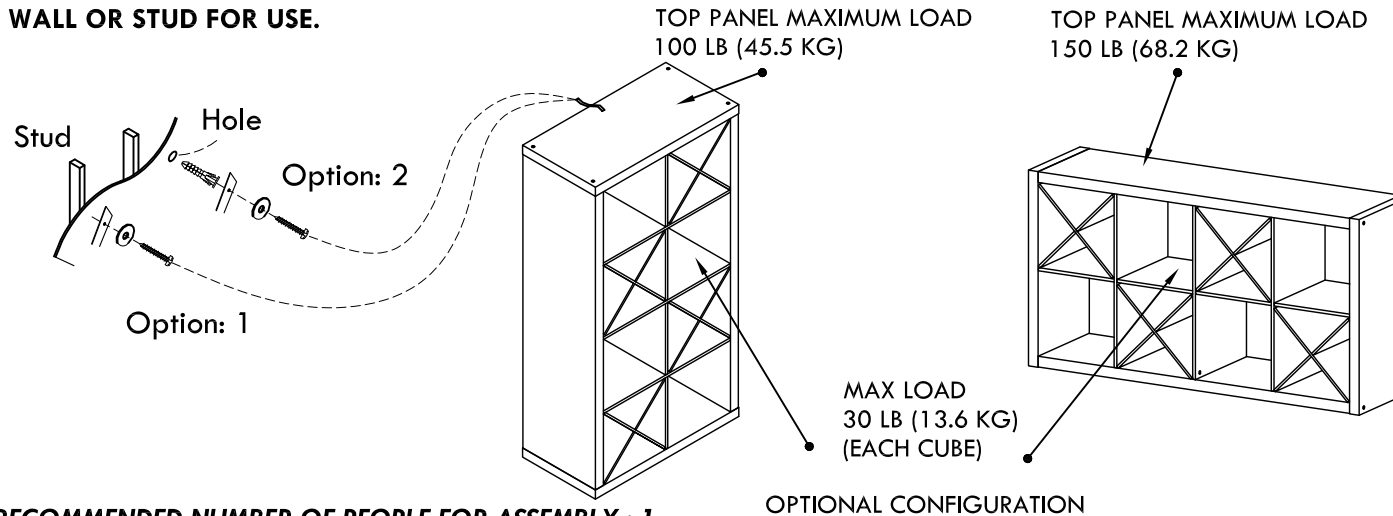

RECOMMENDED NUMBER OF PEOPLE FOR ASSEMBLY : 1
ESTIMATED ASSEMBLY TIME: 1 HOUR

- CALL OUR TOLL FREE NUMBER **1-800-729-1569** FOR FURTHER ASSISTANCE.
- ADDITIONAL PARTS ARE AVAILABLE FOR A FEE.
- THIS INSTRUCTION BOOKLET CONTAINS **IMPORTANT** SAFETY INFORMATION. PLEASE READ AND KEEP FOR FUTURE REFERENCE.
- DO NOT ALLOW CHILDREN TO CLIMB OR PLAY ON THE UNIT.
- CLEAN THE PRODUCT WITH YOUR FAVORITE FURNITURE POLISH AND A SOFT CLOTH.
- DO NOT USE HARSH CHEMICALS OR ABRASIVE CLEANERS.
- MOVE YOUR NEW FURNITURE CAREFULLY WITH TWO PEOPLE. NEVER PUSH OR DRAG THE UNIT.

**DO NOT RETURN THE PRODUCT TO THE STORE.
INDIVIDUAL STORES DO NOT STOCK PARTS.
FOR MISSING OR DAMAGED PARTS CALL
1-800-729-1569.
PARTS WILL BE SHIPPED FREE OF CHARGE.**

**FOR PROMPT, RELIABLE SERVICE, PLEASE HAVE
YOUR ASSEMBLY MANUAL READY.**

LOT NUMBER _____
DATE OF PURCHASE ___/___/___

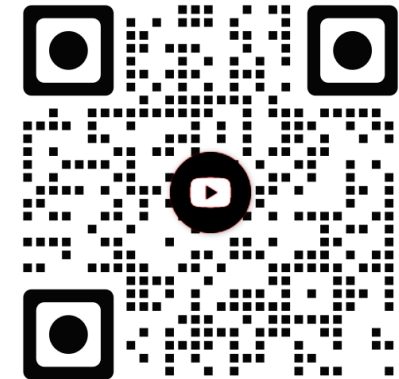

Open your camera and scan the
code above for a video assembly
guide

Megaprima Home Pte Ltd.
Designed in the USA
Made in Malaysia



We are available to assist you Monday -Friday
from 9:00 am - 5:00 pm Eastern Standard Time.
1-800-729-1569
USA only.

BETTER HOMES & GARDENS 8-CUBE STORAGE ORGANIZER WITH 4 X INSERTS

VENDOR STOCK NUMBERS
BH5336278612067-WHITE TEXTURE
BH5336278612068-TOBACCO OAK



BEFORE STARTING

- Read and understand all the steps carefully before starting. If each step is not followed in the correct order the assembly will be difficult and may result in damages.
- Work in a spacious area, preferably on a carpeted surface, near where the unit will be used.
- Make sure all the parts are included. Most boards are labeled with a removable sticker.

Helpful hints

- Call our toll free number if you need assistance. We are available to assist you Monday - Friday from 9:00 am - 5:00 pm Eastern Standard Time.
- **1-800-729-1569** USA only. Or submit a request through our self-service portal at www.huisenfurniture.zendesk.com

TOOLS NEEDED TO ASSEMBLE

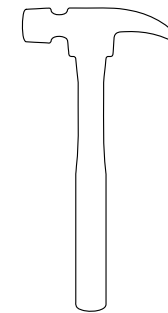
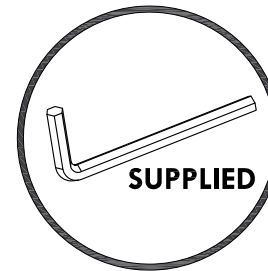

hammer



flat head
screwdriver

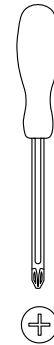

Phillips head
screwdriver



DO NOT USE POWER TOOLS TO ASSEMBLE YOUR FURNITURE. POWER TOOLS MAY RESULT IN DAMAGE.

Megaprima Home Pte Ltd.
Designed in the USA
Made in Malaysia



We are available to assist you Monday -Friday from 9:00 am - 5:00 pm Eastern Standard Time.
1-800-729-1569
USA only.

BETTER HOMES & GARDENS 8-CUBE STORAGE ORGANIZER WITH 4 X INSERTS

VENDOR STOCK NUMBERS
BH5336278612067-WHITE TEXTURE
BH5336278612068-TOBACCO OAK

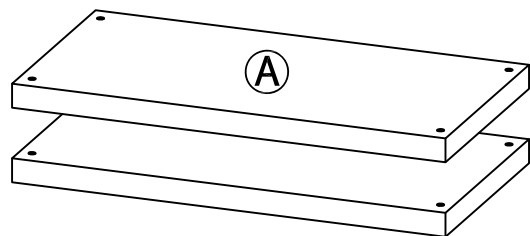

Top/bottom panel
(Qty: 2)

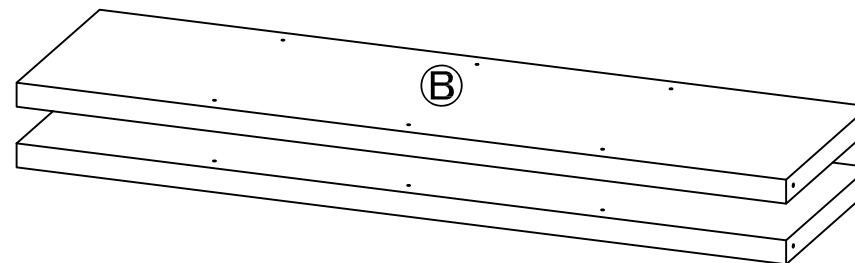

Side panel
(Qty: 2)

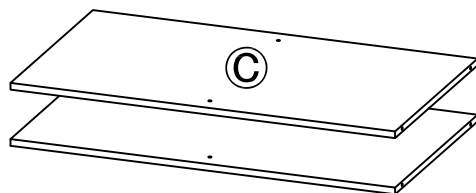

Middle shelf
(Qty: 2)

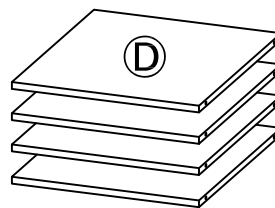

Partition board
(Qty: 4)

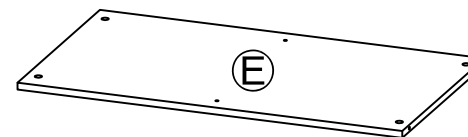

Fixed middle shelf
(Qty: 1)

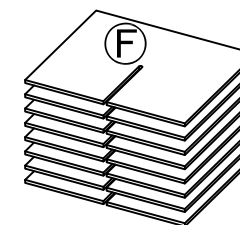

Shelf
(Qty: 8)

VERIFY THAT ALL PARTS ARE PRESENT BEFORE BEGINNING



We are available to assist you Monday -Friday
from 9:00 am - 5:00 pm Eastern Standard Time.
1-800-729-1569
USA only.

BETTER HOMES & GARDENS 8-CUBE STORAGE ORGANIZER WITH 4 X INSERTS

VENDOR STOCK NUMBERS
BH5336278612067-WHITE TEXTURE
BH5336278612068-TOBACCO OAK

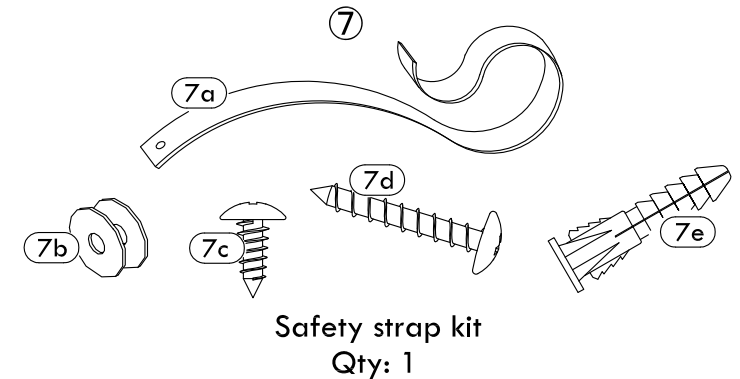
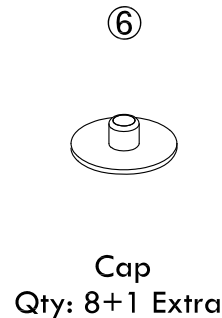
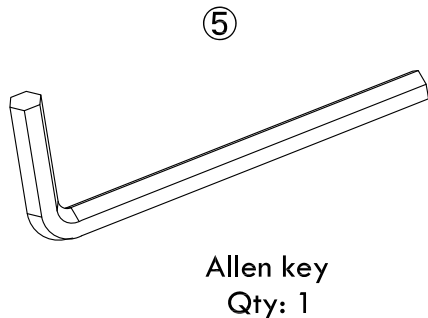
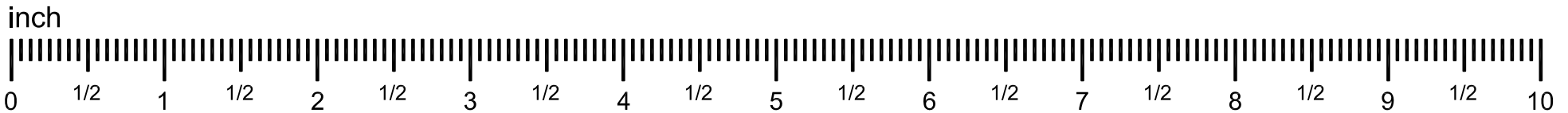
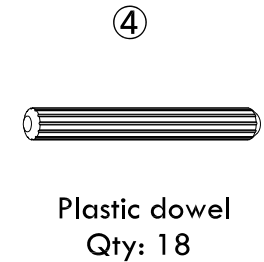
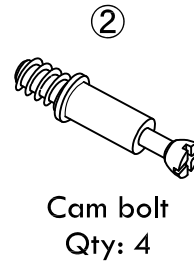
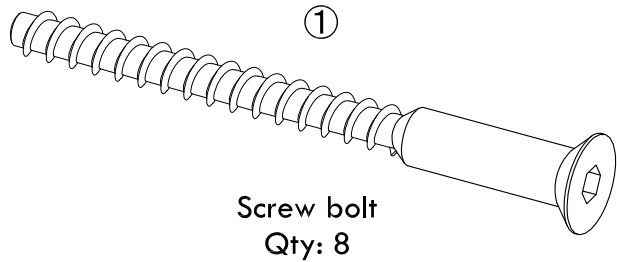

VERIFY THAT ALL PARTS ARE PRESENT BEFORE BEGINNING



We are available to assist you Monday -Friday
from 9:00 am - 5:00 pm Eastern Standard Time.
1-800-729-1569
USA only.

BETTER HOMES & GARDENS 8-CUBE STORAGE ORGANIZER WITH 4 X INSERTS

VENDOR STOCK NUMBERS
BH5336278612067-WHITE TEXTURE
BH5336278612068-TOBACCO OAK

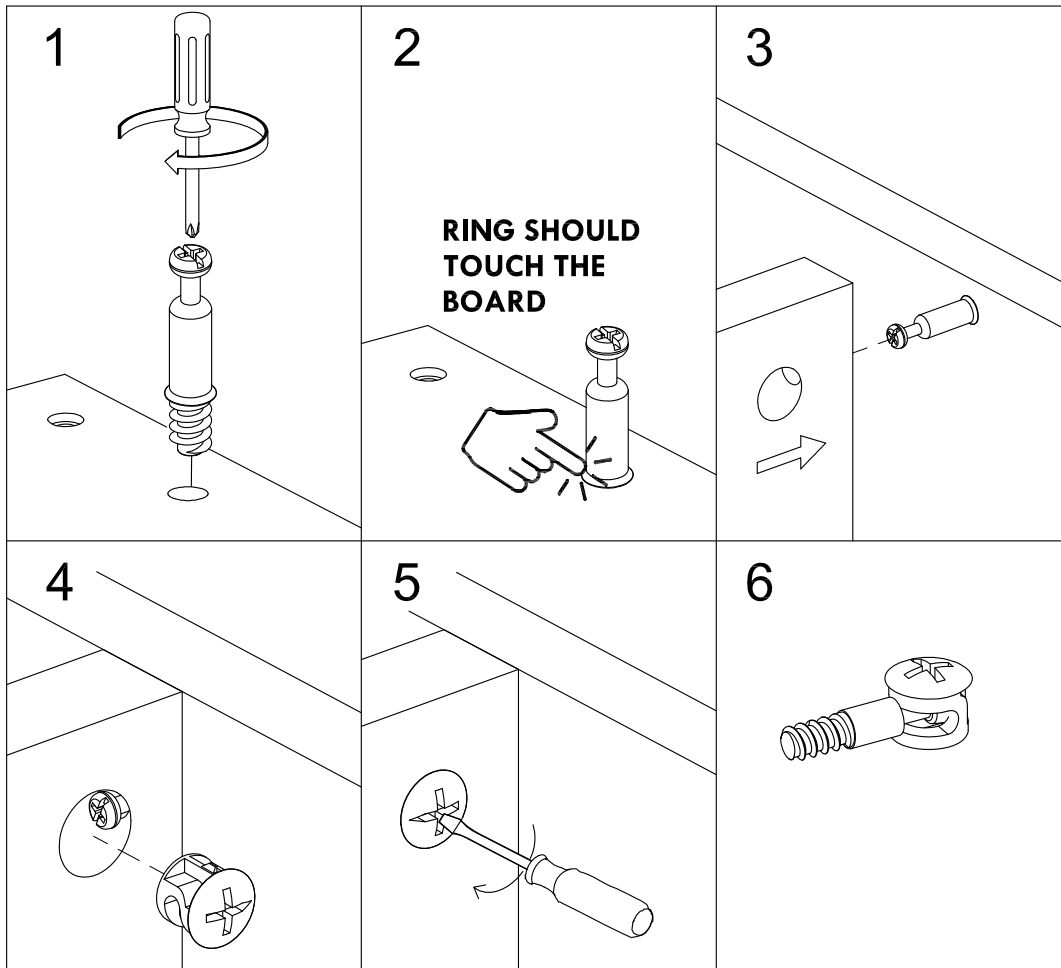

CAM FASTENING SYSTEM EXAMPLE

1. Screw the **cam bolt** into the predrilled panel. The screw should be tightened so no threads are visible.
2. The larger ring of the cam should touch the panel.
3. Connect the previously tightened cam bolt to the panel.
4. Insert the **cam lock** into the predrilled hole in the panel. Arrow should face the predrilled hole in the edge of panel.
5. Using a flat head screw driver, turn the **cam lock** halfway clockwise to secure the **cam bolt**.
6. **FAILURE TO PROPERLY SECURE THE CAM LOCK AND CAM BOLT COULD RESULT IN PRODUCT INSTABILITY AND FAILURE.**

Megaprima Home Pte Ltd.
Designed in the USA
Made in Malaysia



We are available to assist you Monday -Friday
from 9:00 am - 5:00 pm Eastern Standard Time.
1-800-729-1569
USA only.

1

Insert **two** plastic dowels ④ into **three** of the ① panels.
Insert **four** plastic dowels ④ into **one** of the ① panels.
Insert **four** plastic dowels ④ into ② panels.
Push dowels into predrilled holes leaving 1 1/4" exposed.

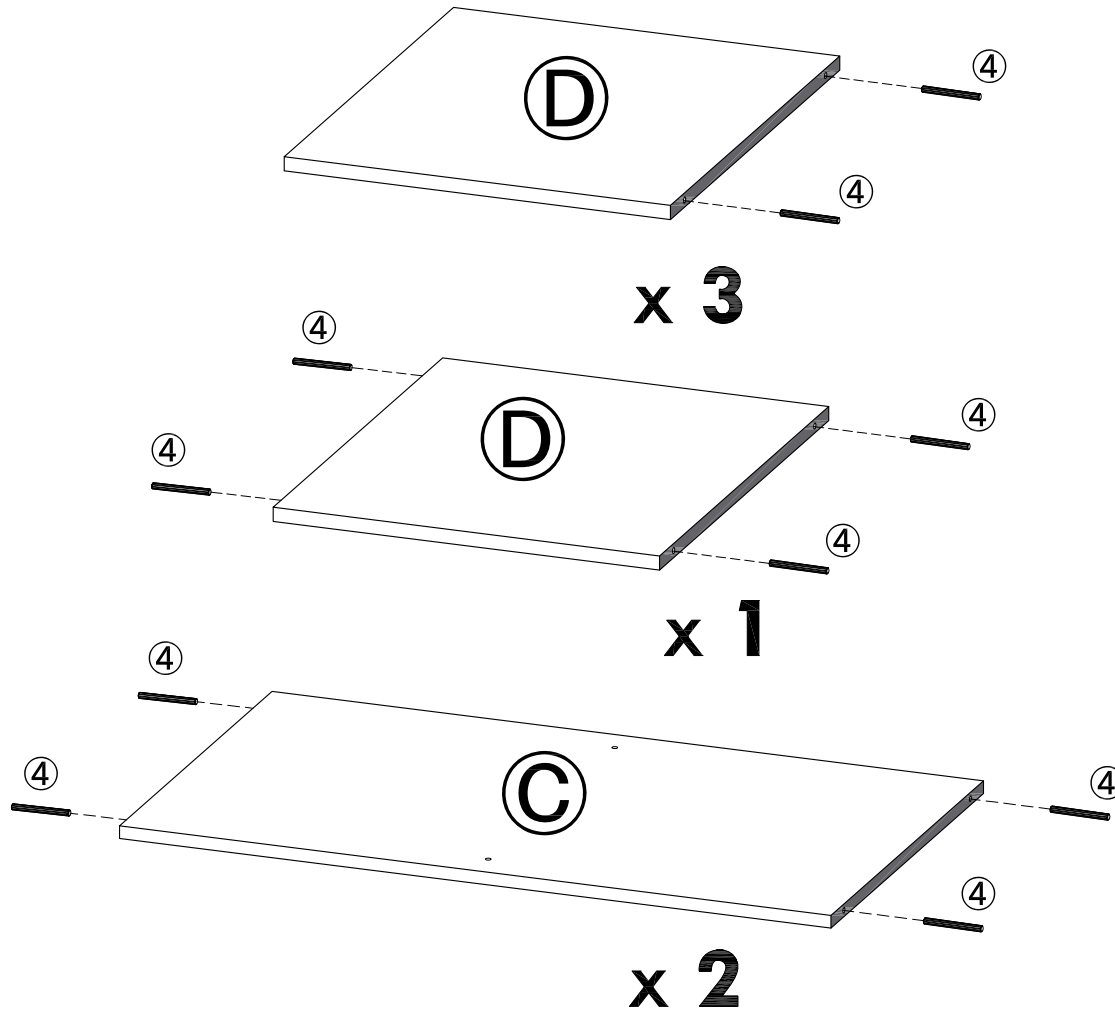

ADDITIONAL NOTES

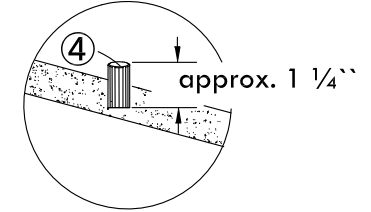

PARTS

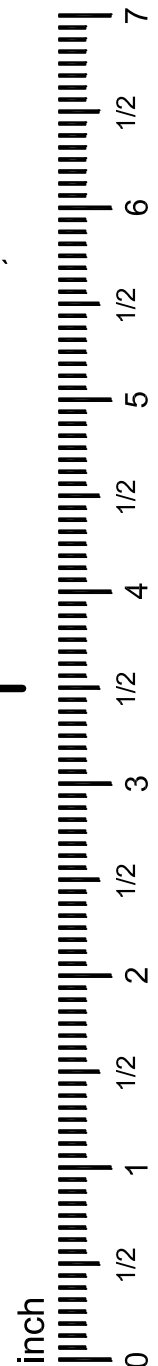
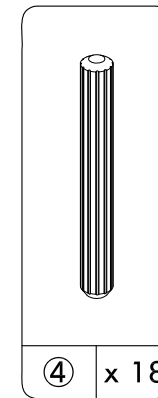

2

Screw cam bolts ② into ③ panels.

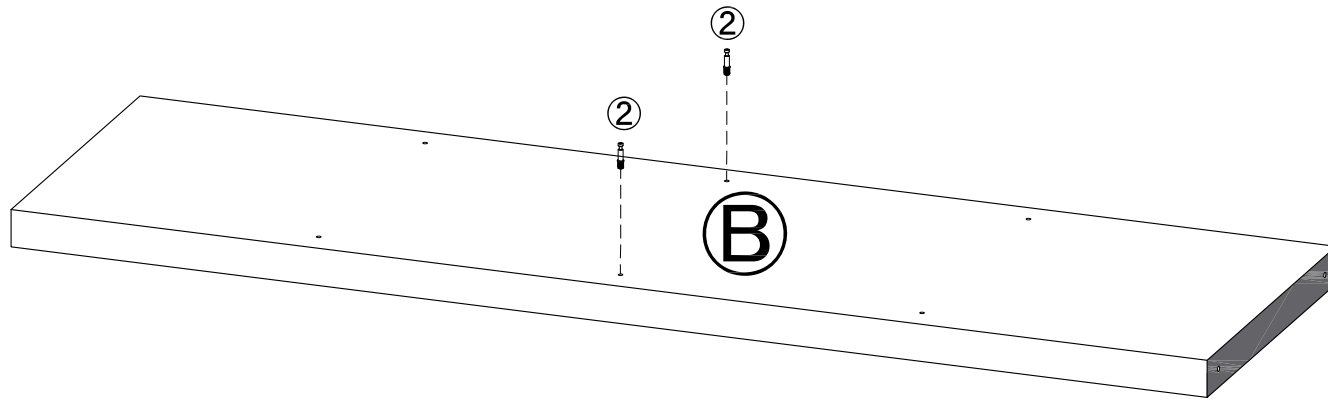

x 2

ADDITIONAL NOTES

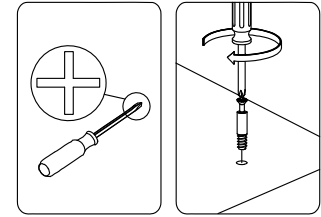

PARTS

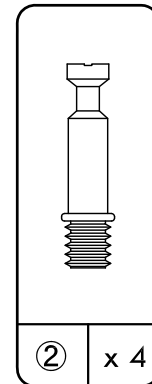

② x 4

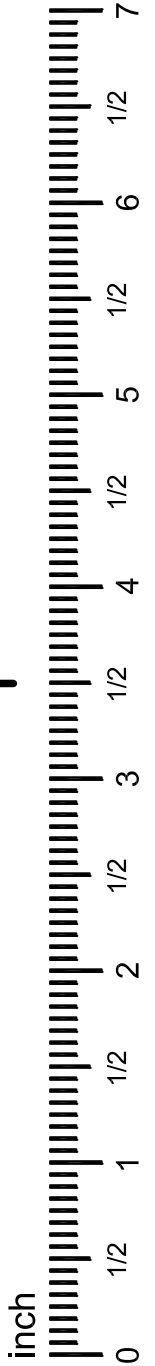

3

Align and attach ④ panels between ③ & ⑤ panels.

PAY ATTENTION TO DIRECTION OF DOWELS IN D PANELS.

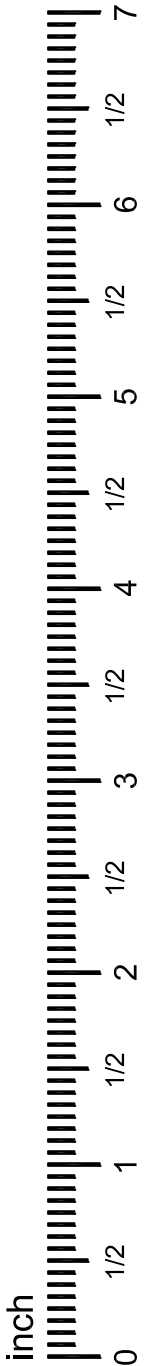
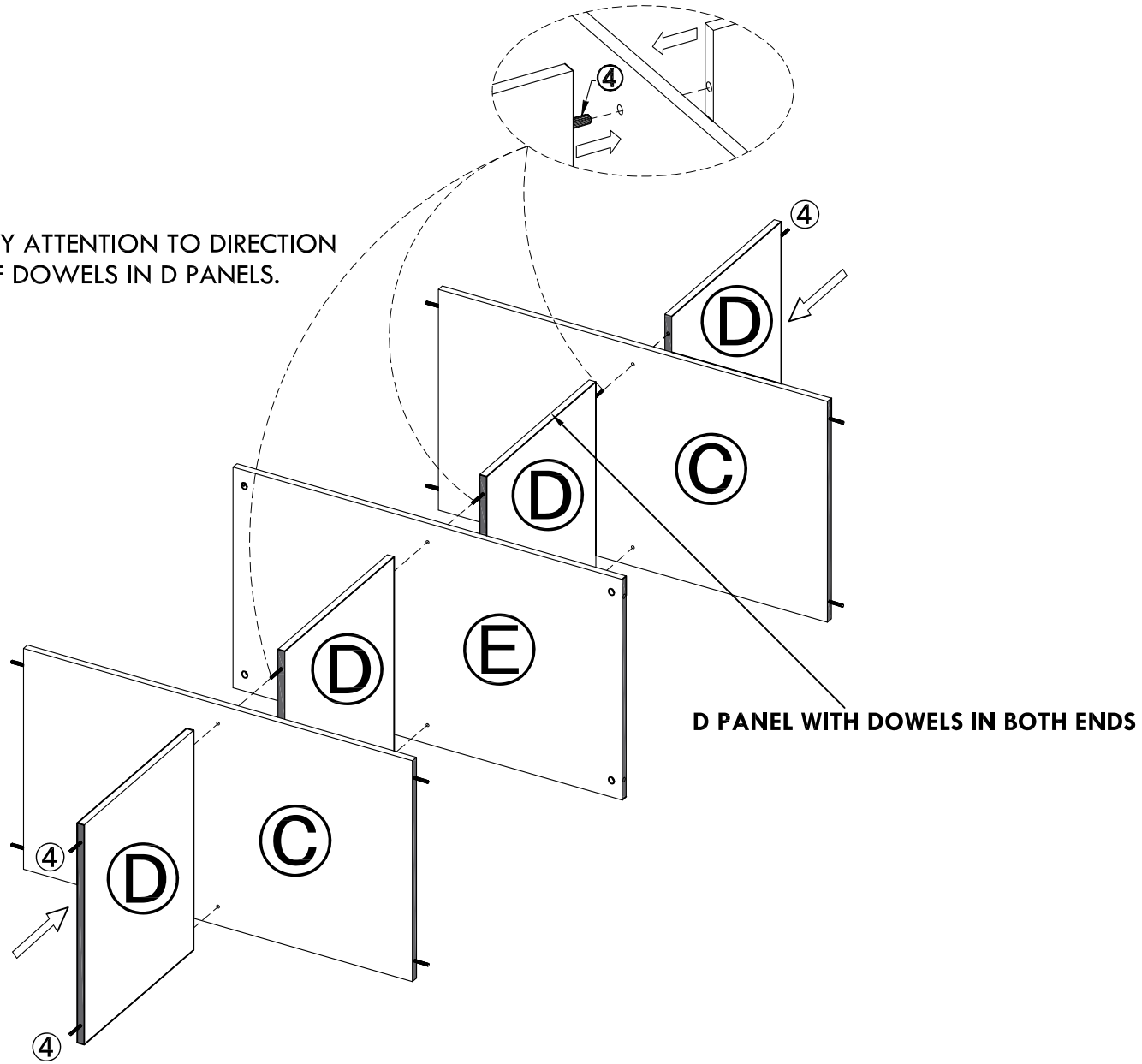

4

Connect **B** panels to structure.
 Insert cam locks **3** into **E** panel and tighten cam locks **3**.
▲ WARNING
 Do not move product until A (top/bottom) panels are attached.
 Failure to follow this could result in product damage and failure.

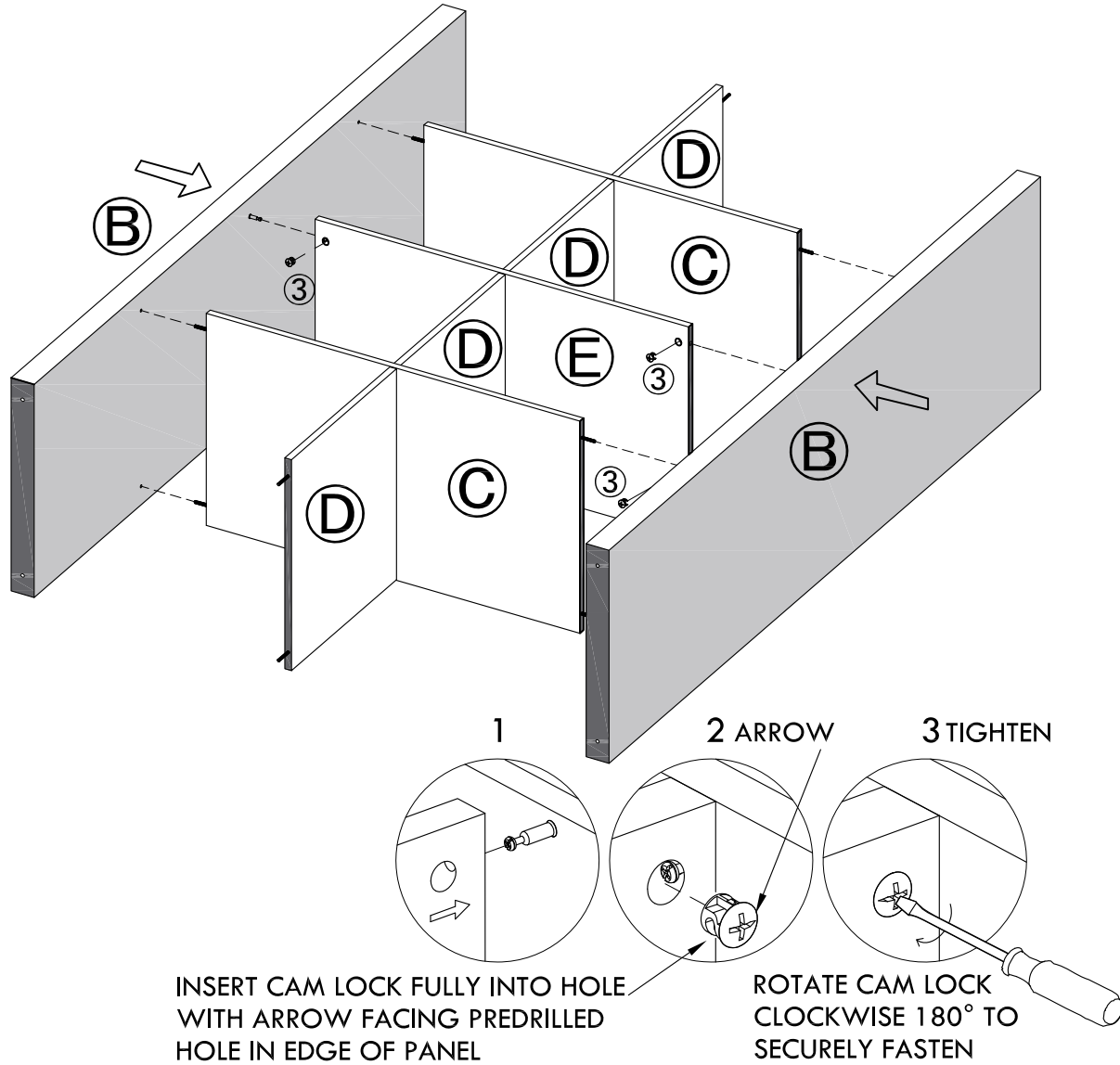

ADDITIONAL NOTES

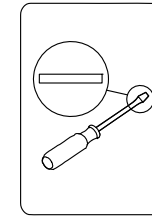

PARTS

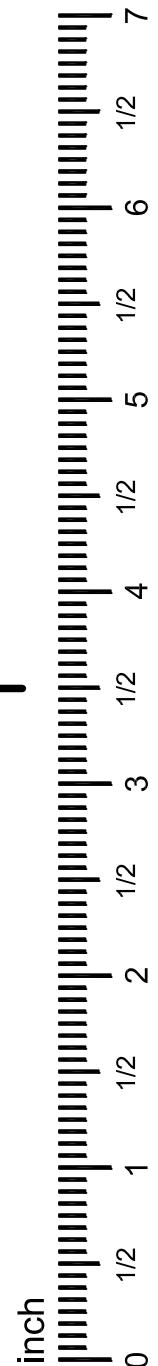

5

Use screw bolt ① to attach ① panels to structure.

Use caps ⑥ to cover exposed screw heads in ① panels.

If unit is going to be used vertically, attach wall strap ⑦a to top ① panel. Use parts ⑦b & ⑦c to attach strap in the center of the edge of ① panel (location marked by orange sticker).

⚠ WARNING

Do not move product until A (top/bottom) panels are attached. Failure to follow this could result in product damage and failure.

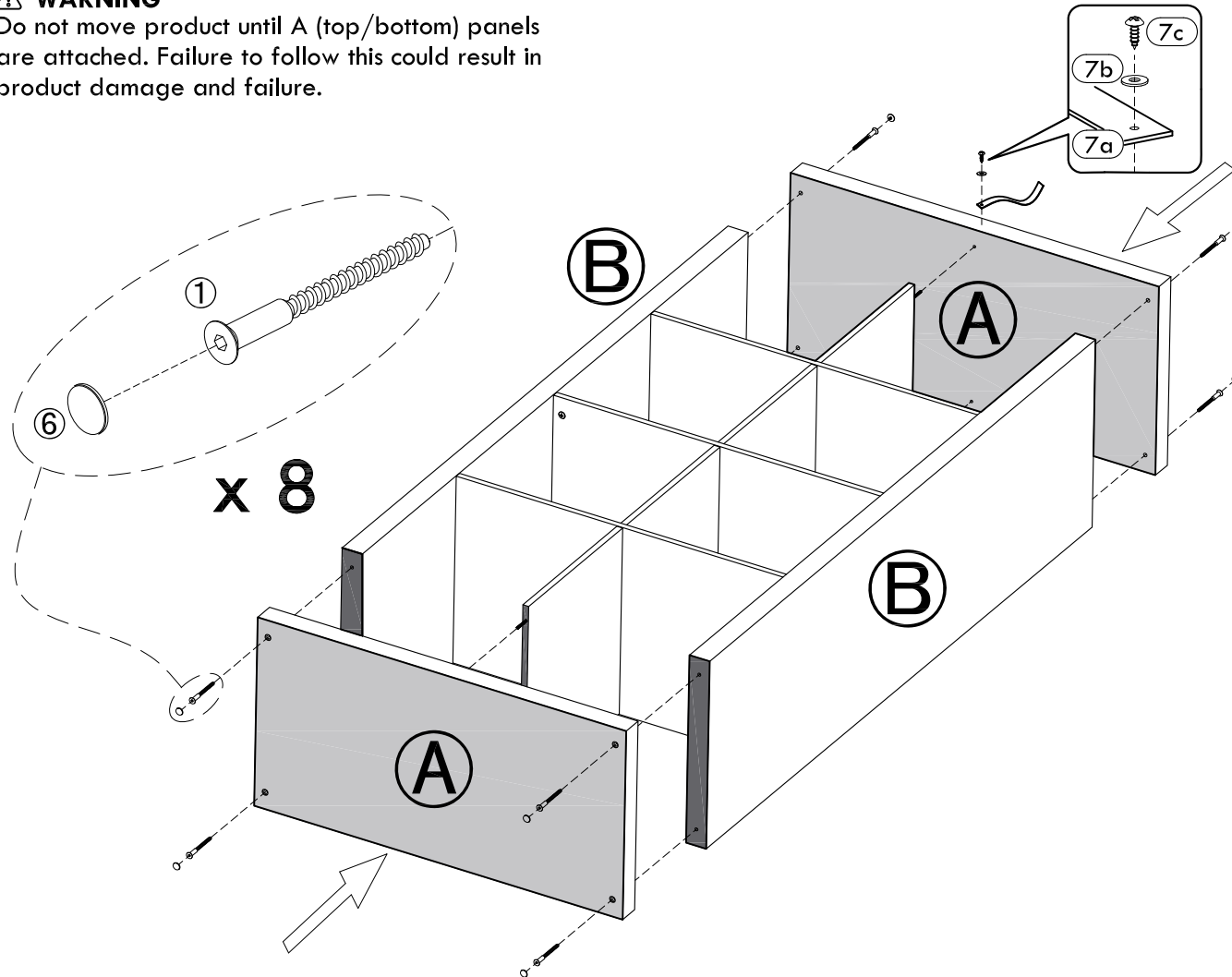

ADDITIONAL NOTES

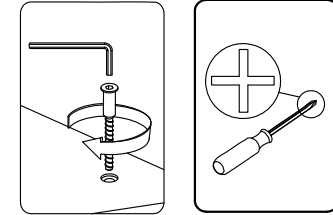

PARTS

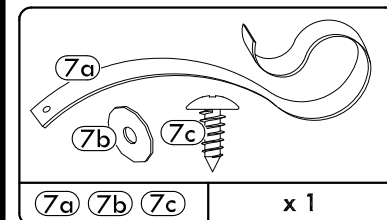
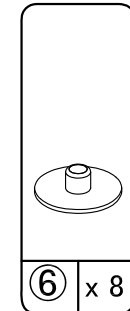
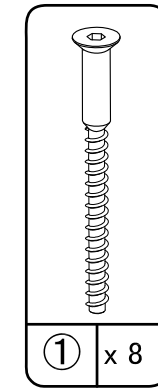

6

Fasten safety strap to wall using Option 1 or Option 2 as shown below.

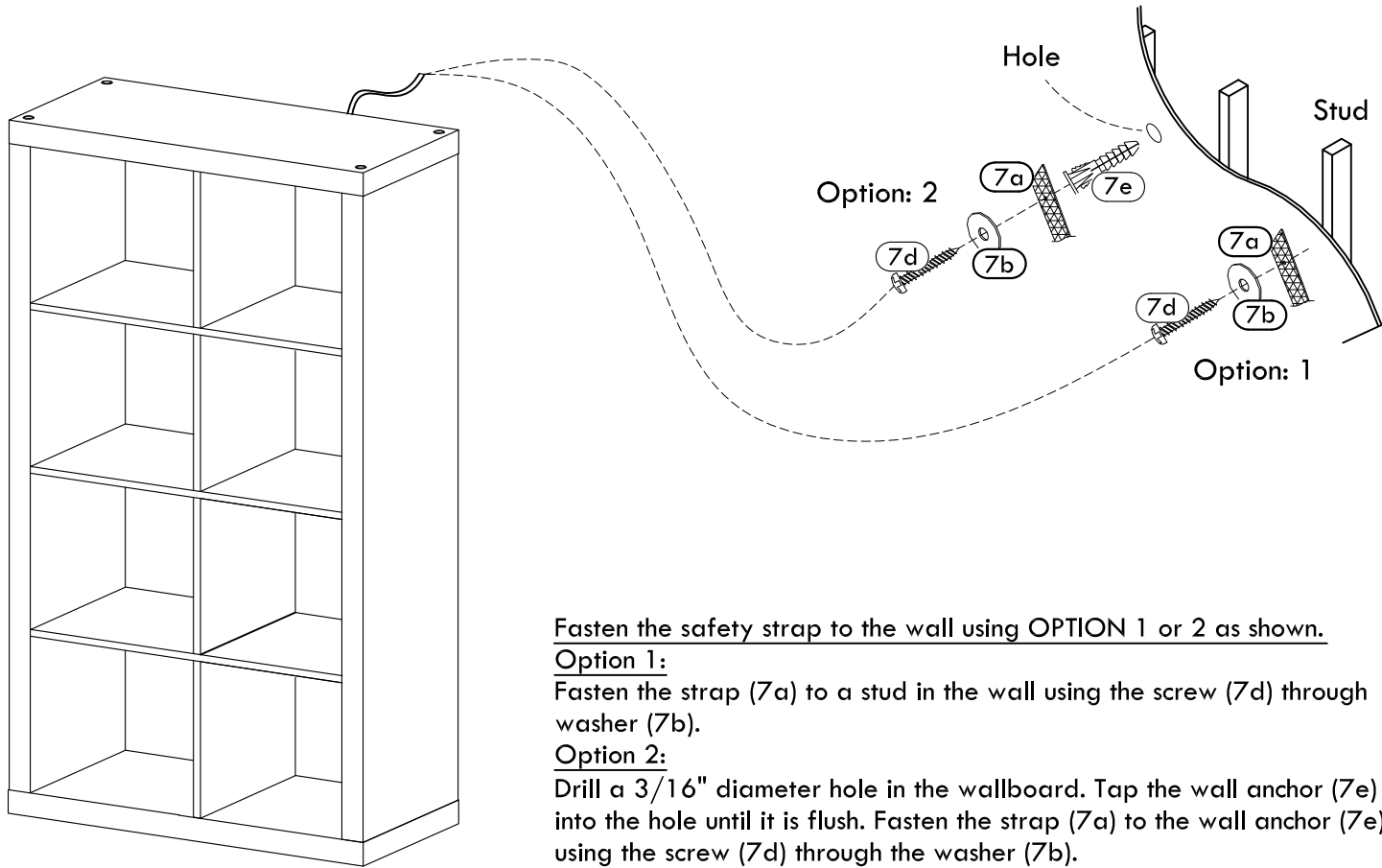

Fasten the safety strap to the wall using OPTION 1 or 2 as shown.

Option 1:

Fasten the strap (7a) to a stud in the wall using the screw (7d) through washer (7b).

Option 2:

Drill a 3/16" diameter hole in the wallboard. Tap the wall anchor (7e) into the hole until it is flush. Fasten the strap (7a) to the wall anchor (7e) using the screw (7d) through the washer (7b).

ADDITIONAL NOTES

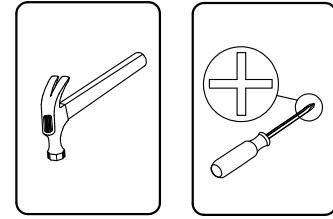

PARTS

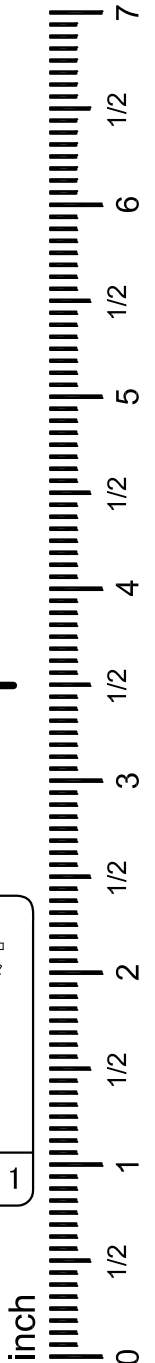
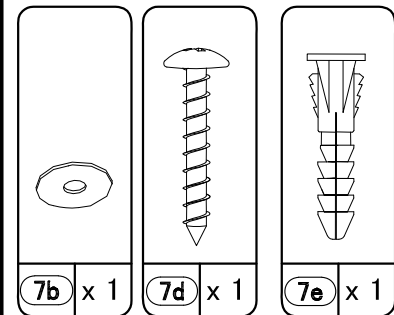

7

Slide one (F) panel into the other at the slotted position as shown below.

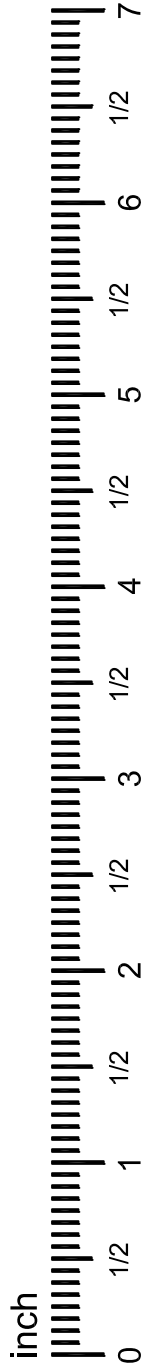
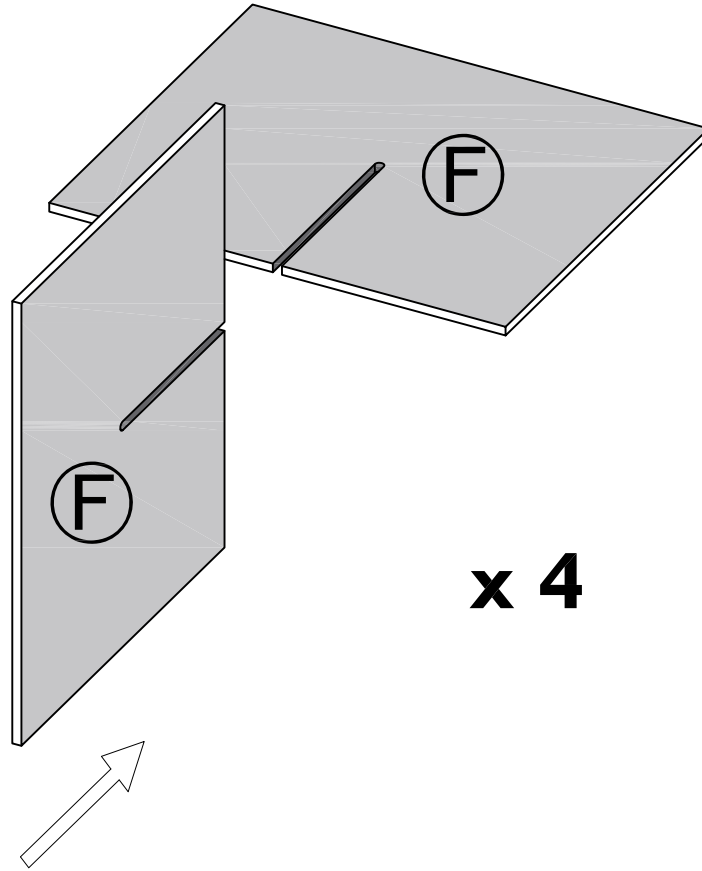

8

Insert assembled piece into the Better Homes & Gardens Cube Organizer shelf of your choice.

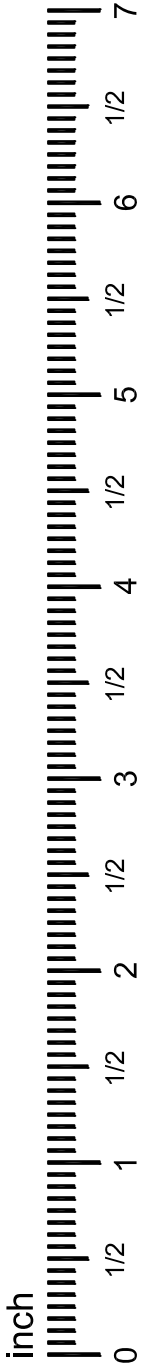
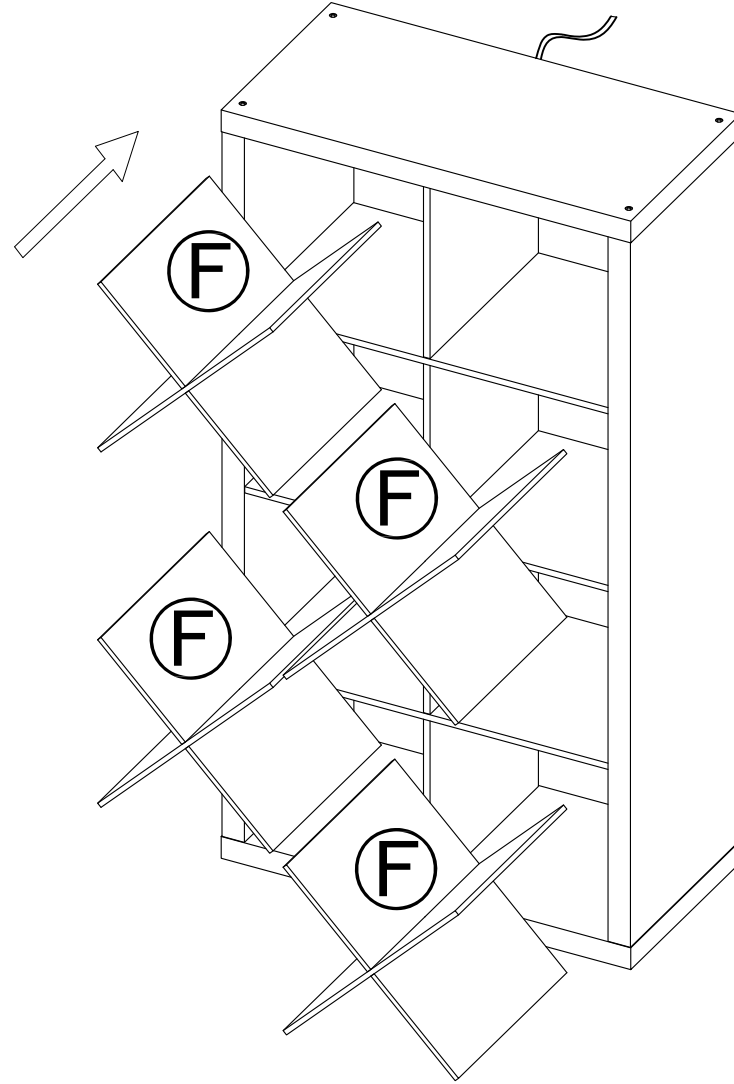

CONGRATULATIONS, YOUR UNIT IS COMPLETE, PLEASE ENJOY AND BE SURE TO TELL US ABOUT YOUR EXPERIENCE!

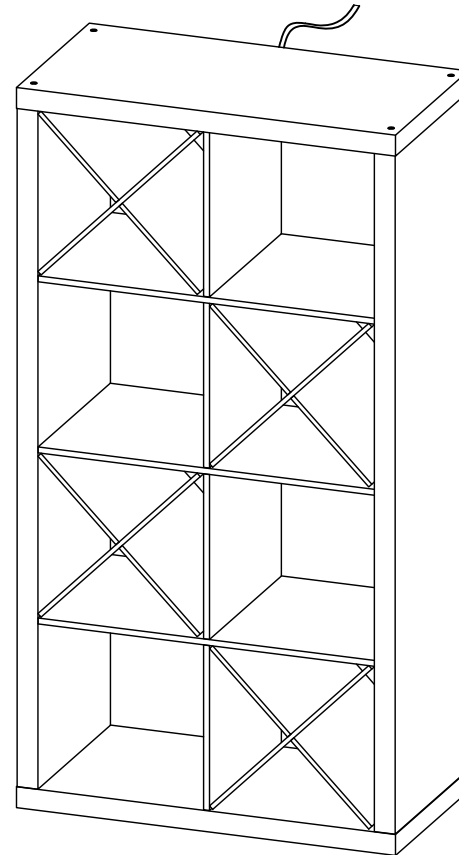

Quality Guarantee

Should this product be defective in workmanship or materials or fail under normal use, we will repair or replace it for up to (1) year from date of purchase.

This warranty gives you specific legal rights and you may also have other rights which vary from State to State.

**Please call for replacement parts or assistance: 1-800-729-1569
Monday - Friday 9:00 am - 5:00 pm EST**

BETTER HOMES & GARDENS ORGANIZADOR DE 8 CUBOS CON 4 X INSERCIONES

NÚMERO DE STOCK DEL VENDEDOR
BH5336278612067-TEXTURA BLANCO
BH5336278612068-ROBLE TABACO

ESTE PRODUCTO DEBE MONTARSE SIEMPRE EN
UNA PARED O EN UN EXTREMO PARA SU USO.

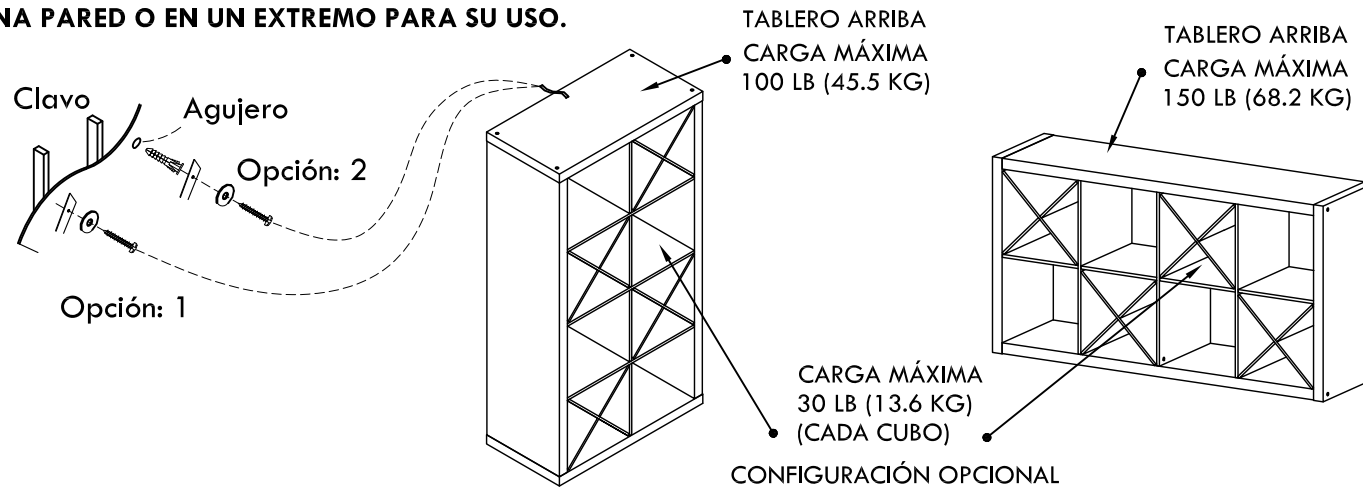

NÚMERO DE PERSONAS RECOMENDADO PARA EL ENSAMBLAJE: 1
TIEMPO ESTIMADO DE ENSAMBLAJE: 1 HORA

- LLAME A NUESTRO NÚMERO GRATUITO **1-800-729-1569** PARA OBTENER MÁS AYUDA.
- PIEZAS ADICIONALES ESTÁN DISPONIBLES POR UNA TARIFA.
- ESTE MANUAL DE INSTRUCCIÓN CONTIENE INFORMACIÓN **IMPORTANTE** DE SEGURIDAD. POR FAVOR DE LEER Y GUARDAR PARA FUTURAS REFERENCIAS.
- NO DEJAR A LOS NIÑOS SUBIR O JUGAR SOBRE LA UNIDAD.
- LIMPIAR EL PRODUCTO CON TU PULIDOR FAVORITE DE MUEBLE Y UN TRAPO BLANDO.
- NO USAR QUÍMICOS FUERTES O PRODUCTO DE LIMPIEZA ABRASIVO.
- MUEVA SUS NUEVOS MUEBLES CUIDADOSAMENTE CON DOS PERSONAS, NUNCA EMPUJE O ARRASTRE LA UNIDAD.

NO DEVOLVER EL PRODUCTO A LA TIENDA.
TIENDAS INDIVIDUALES NO RESERVAN PIEZAS.
PARA PIEZAS PERDIDAS O DAÑADAS LLAME AL
1-800-729-1569.
PARTES SERÁN ENVIADOS DE FORMA GRATUITA.

PARA UN SERVICIO RÁPIDO Y CONFIABLE, POR
FAVOR DE TENER A MANO EL MANUAL DE
ENSAMBLAJE.

NÚMERO DE PARTIDA _____
FECHA DE COMPRA ____/____/____

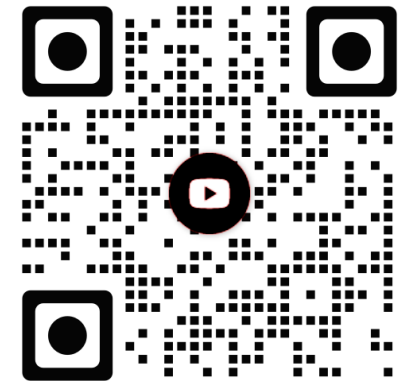

Abra su cámara y escanee el código
arriba para ver la guía de vídeo de
ensamblaje.

Megaprima Home Pte Ltd.
Diseñado en el E.E.U.U.
Hecho en Malaysia



Estamos disponibles para ayudarlo de Lunes - Viernes
de 9:00 am - 5:00 pm Hora de la Zona Este.
1-800-729-1569
Sólo E.E.U.U.

BETTER HOMES & GARDENS ORGANIZADOR DE 8 CUBOS CON 4 X INSERCIONES

NÚMERO DE STOCK DEL VENDEDOR
BH5336278612067-TEXTURA BLANCO
BH5336278612068-ROBLE TABACO



ANTES DE COMENZAR

- Leer y entender todos los pasos cuidadosamente antes de comenzar. si no se sigue cada paso en el orden correcto, el montaje será difícil y puede ocasionar daños.
- Trabajar en una zona amplia, mejor sobre la alfombra, cerca del sitio donde la unidad se utiliza.
- Asegurarse de que todas las piezas estén incluidos. La mayoría de los tableros están etiquetados con una pegatina removible.

Consejos útiles

- Llamar a nuestro número gratis para ayuda. Estamos disponibles para ayudarlo de lunes - Viernes de 9:00 am - 5:00 pm hora de la zona este.
- **1-800-729-1569** Sólo E.E.U.U.
O haga una solicitud a través de nuestro portal de autoservicio en www.huisenfurniture.zendesk.com

HERRAMIENTAS NECESARIAS PARA ENSAMBLAR

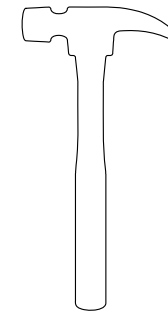

martillo

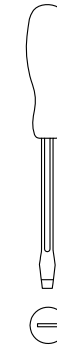

destornillador de
cabeza plana

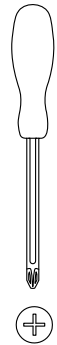

destornillador de
cabeza phillips



**NO UTILICE HERRAMIENTAS ELÉCTRICAS
PARA MONTAR SUS MUEBLES.
HERRAMIENTAS ELÉCTRICAS PUEDEN
PROVOCAR DAÑOS.**

Megaprima Home Pte Ltd.
Diseñado en el E.E.U.U.
Hecho en Malaysia



Estamos disponibles para ayudarlo de Lunes - Viernes de 9:00 am - 5:00 pm Hora de la Zona Este.
1-800-729-1569
Sólo E.E.U.U.

BETTER HOMES & GARDENS ORGANIZADOR DE 8 CUBOS CON 4 X INSERCIONES

NÚMERO DE STOCK DEL VENDEDOR
BH5336278612067-TEXTURA BLANCO
BH5336278612068-ROBLE TABACO

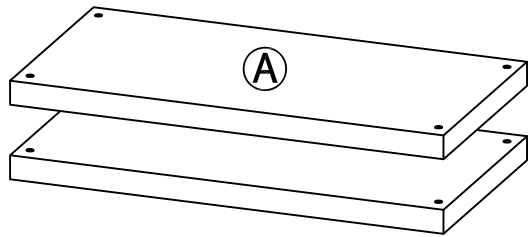

Barra arriba/abajo
(Cantidad: 2)

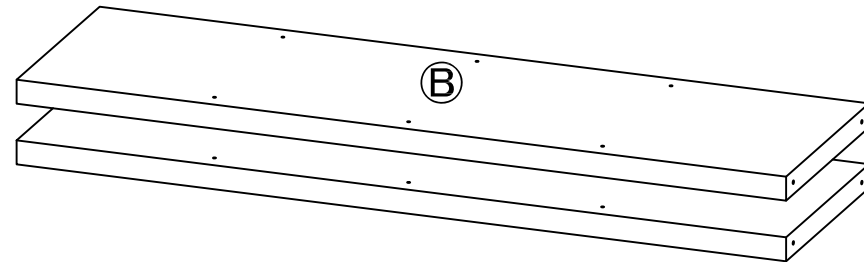

Barra lateral
(Cantidad: 2)

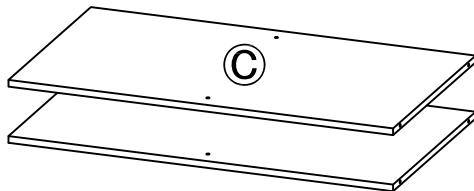

Estante del medio
(Cantidad: 2)



Tabla de tabique
(Cantidad: 4)



Estante del medio para fijo
(Cantidad: 1)

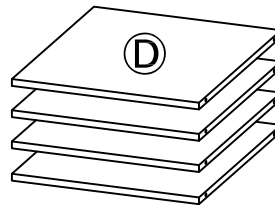
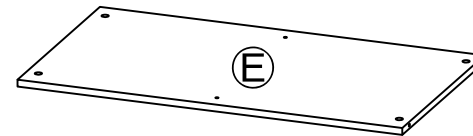
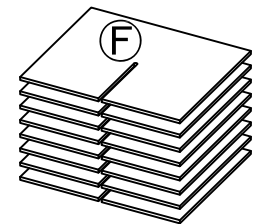

Estante
(Cantidad: 8)

**VERIFIQUE QUE TODAS LAS PIEZAS ESTÉN EN LA LISTA ANTES
DE COMENZAR**



Estamos disponibles para ayudarlo de Lunes - Viernes
de 9:00 am - 5:00 pm Hora de la Zona Este.
1-800-729-1569
Sólo E.E.U.U.

BETTER HOMES & GARDENS ORGANIZADOR DE 8 CUBOS CON 4 X INSERCIONES

NÚMERO DE STOCK DEL VENDEDOR
 BH5336278612067-TEXTURA BLANCO
 BH5336278612068-ROBLE TABACO

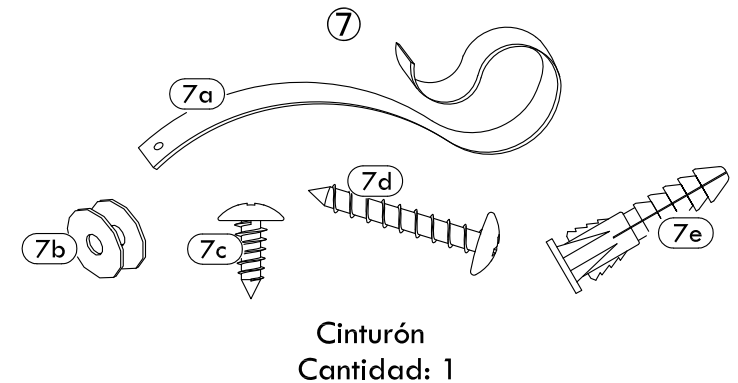
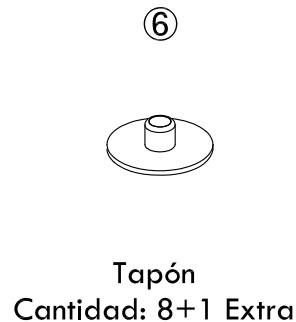
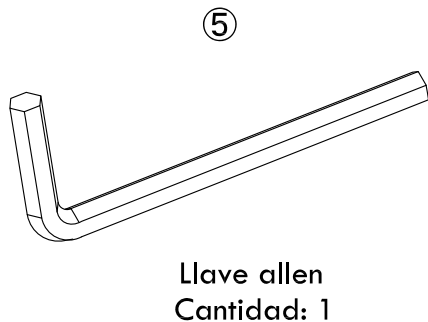
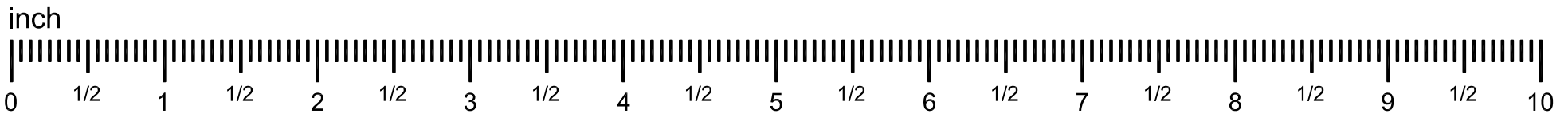
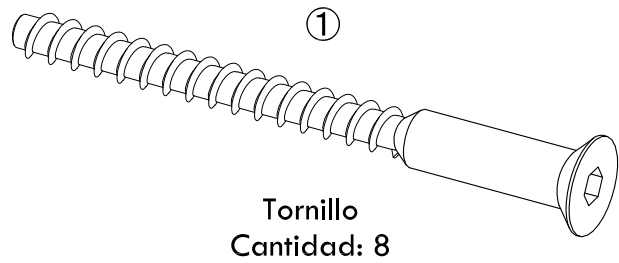

VERIFIQUE QUE TODAS LAS PIEZAS ESTÉN EN LA LISTA ANTES DE COMENZAR



Estamos disponibles para ayudarlo de Lunes - Viernes de 9:00 am - 5:00 pm Hora de la Zona Este.
1-800-729-1569
 Sólo E.E.U.U.

BETTER HOMES & GARDENS ORGANIZADOR DE 8 CUBOS CON 4 X INSERCIONES

NÚMERO DE STOCK DEL VENDEDOR
BH5336278612067-TEXTURA BLANCO
BH5336278612068-ROBLE TABACO

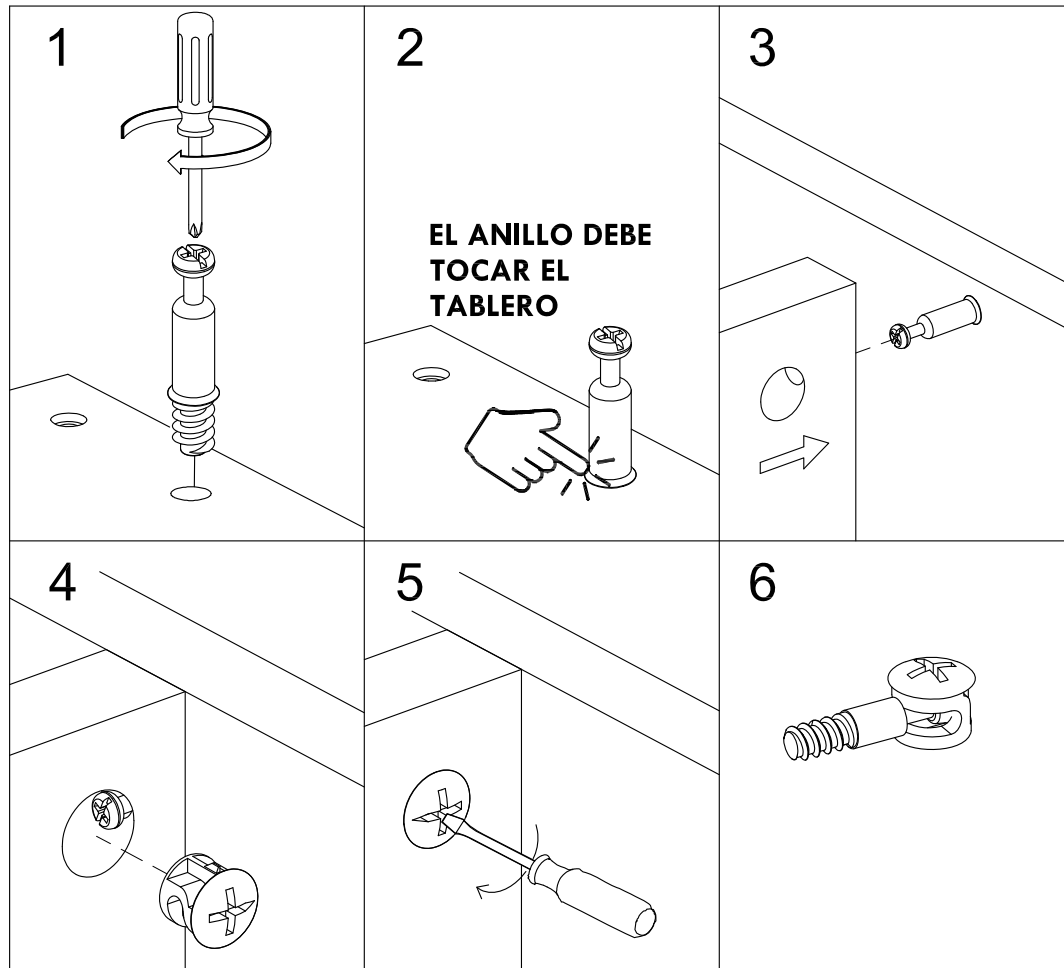

EJEMPLO DE SISTEMA DE CIERRE DE LEVA

1. Atornille el **Tornillo de combadura** en el panel pretaladrado. El tornillo debe apretarse para que no haya roscas visibles.
2. El anillo más grande del cam debe tocar el panel.
3. Conecte el tornillo de combadura previamente apretado a panel.
4. Inserte el **Cerrojo de combadura** en el agujero pretaladrado en el panel. La flecha deberían encararse al agujero perforado en el borde del panel.
5. Usando un destornillador de cabeza plana, gire el **Cerrojo de combadura** hasta la mitad en según las agujas del reloj para asegurar el **Tornillo de combadura**.
6. **SI NO SE ASEGURA ADECUADAMENTE EL CERROJO DE COMBADURA Y EL TORNILLO DE COMBADURA, ODRÍA RESULTAR INESTABILIDAD Y FALLAS EN EL PRODUCTO.**

Megaprima Home Pte Ltd.
Diseñado en el E.E.U.U.
Hecho en Malaysia



Estamos disponibles para ayudarlo de Lunes - Viernes de 9:00 am - 5:00 pm Hora de la Zona Este.
1-800-729-1569
Sólo E.E.U.U.

1

Insertar **dos** clavijas de plástico ④ en **tres** paneles ①.
Insertar **cuatro** clavijas de plástico ④ en **un** paneles ②.
Insertar **cuatro** clavijas de plástico ④ en paneles ③.
Empuje los tapones en el agujero predrillado dejando 1 1/4" expuesto.

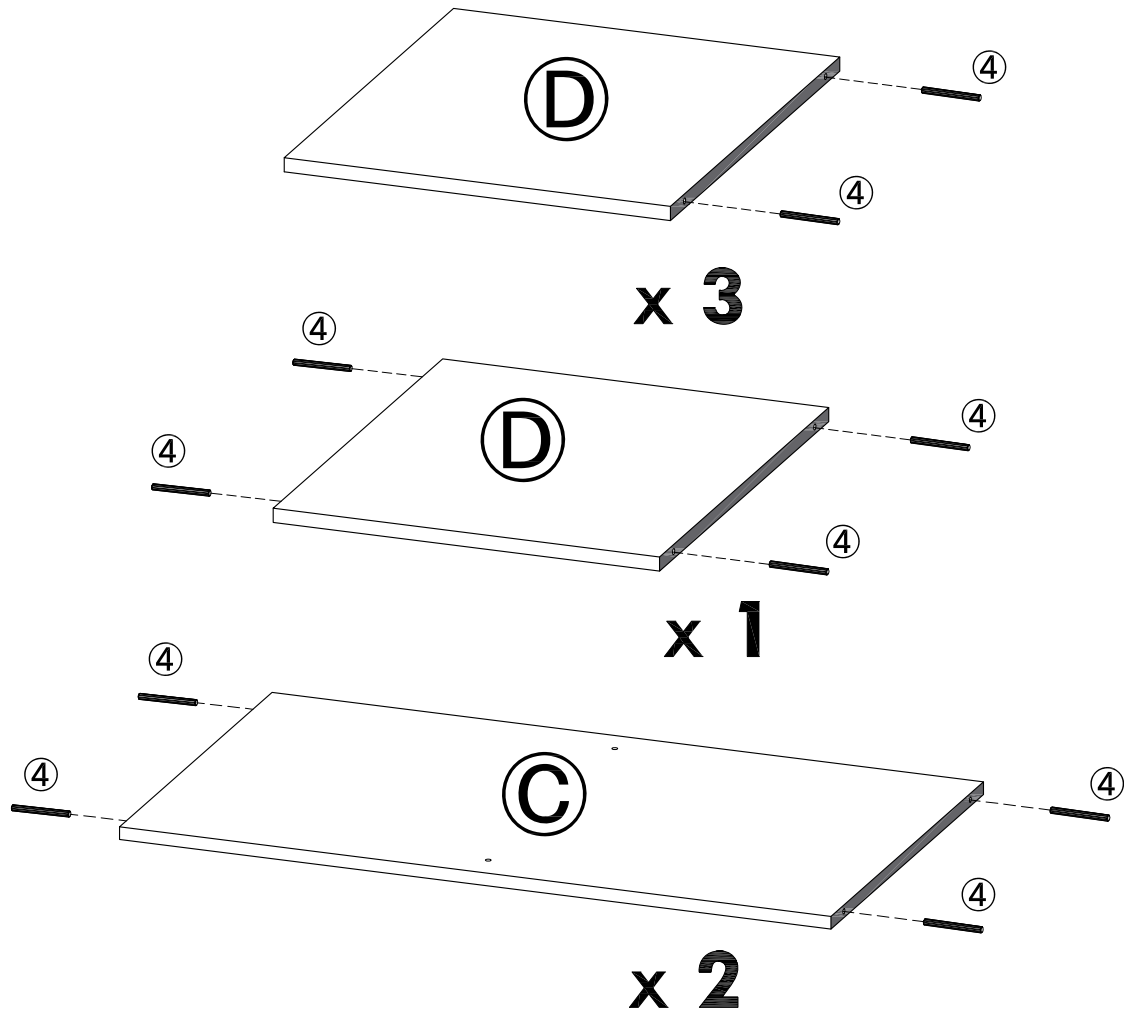

NOTAS ADICIONALES

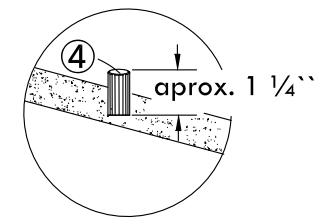

PARTES

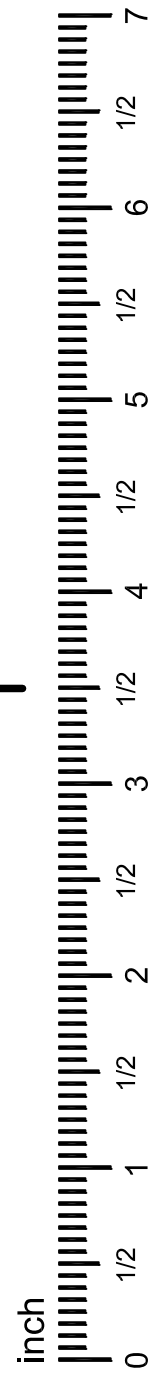
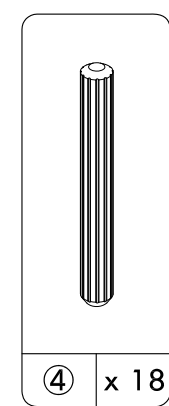

2

Atornillar el cerrojo de combadura ② en el panel ③.

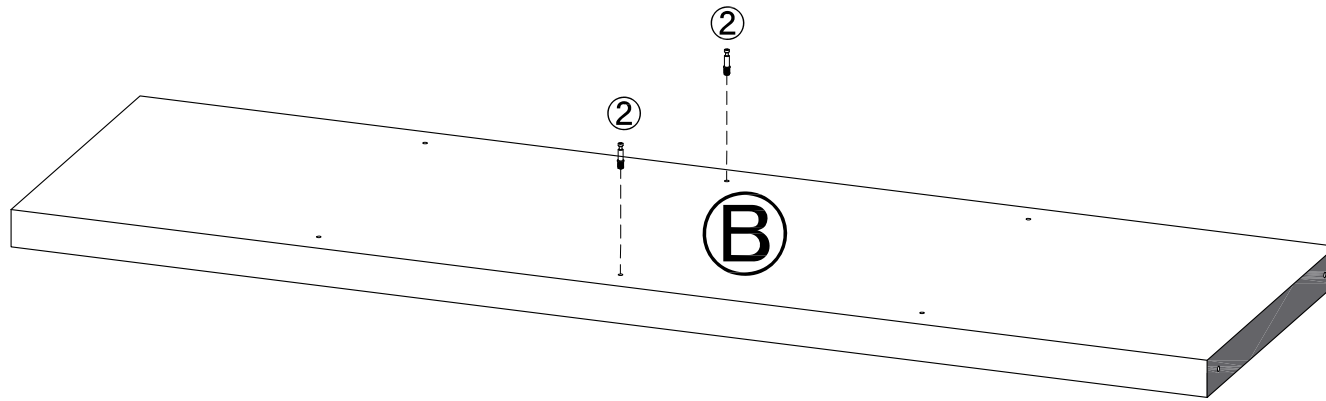

x 2

NOTAS ADICIONALES

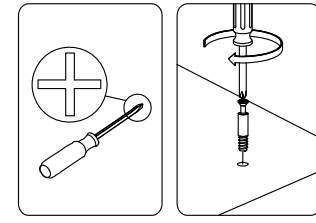

PARTES

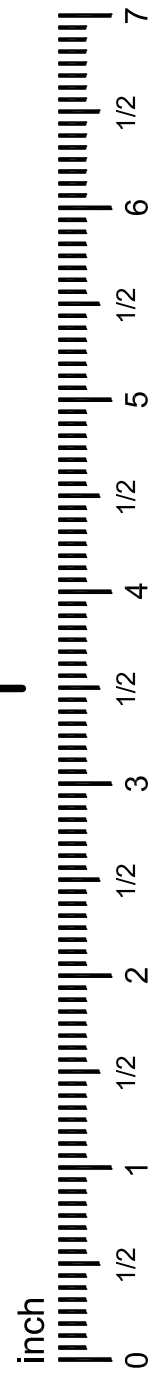
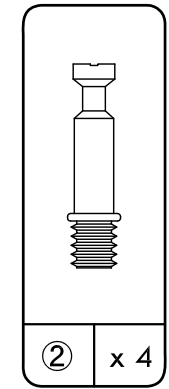

3

Alinee y sujete paneles D entre paneles C y E.

POR FAVOR DE PRESTAR ATENCIÓN
A LA DIRECCIÓN DE LAS CLAVIJAS
EN PANELES D.

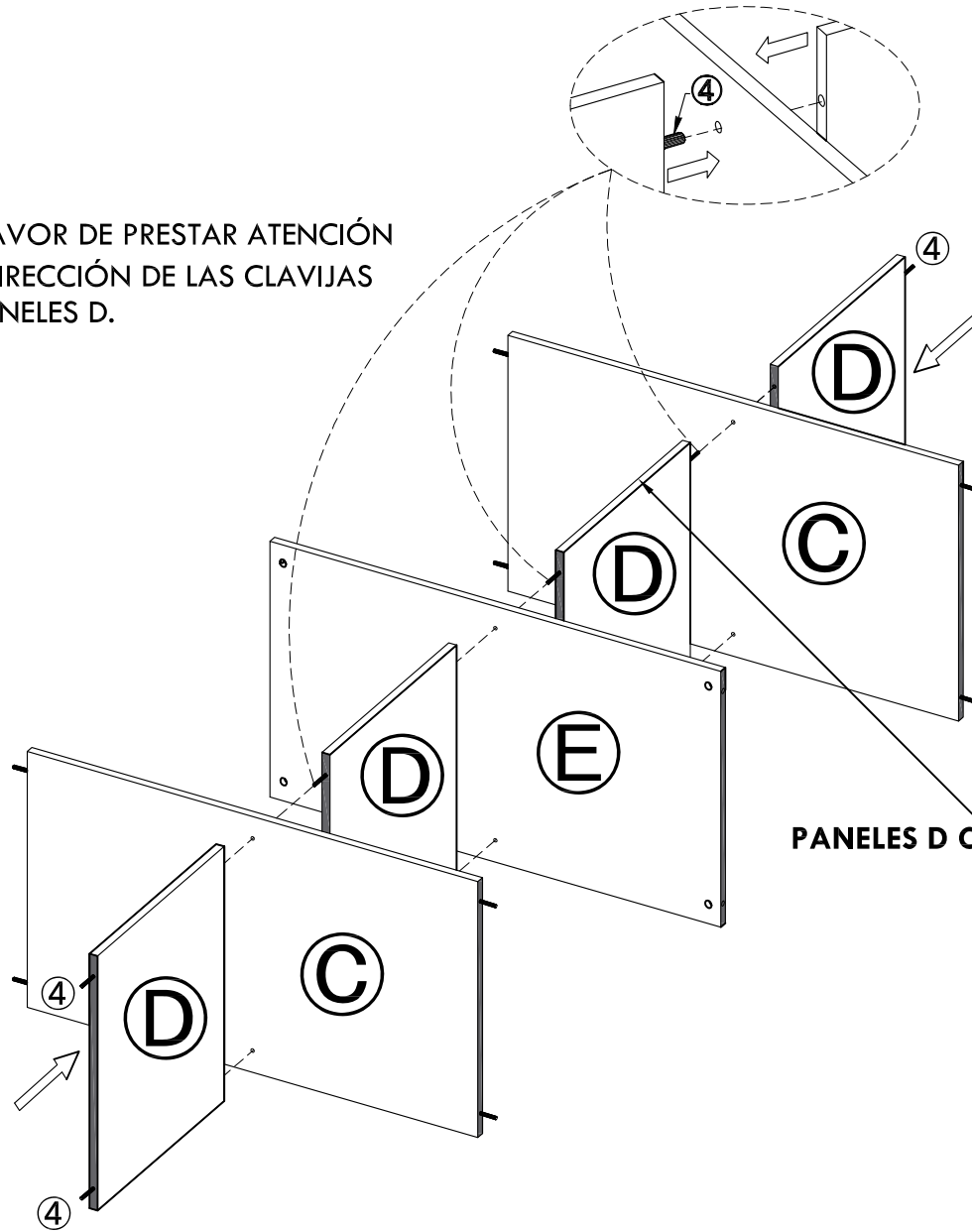

PANELES D CON CLAVIJAS EN AMBOS LADOS

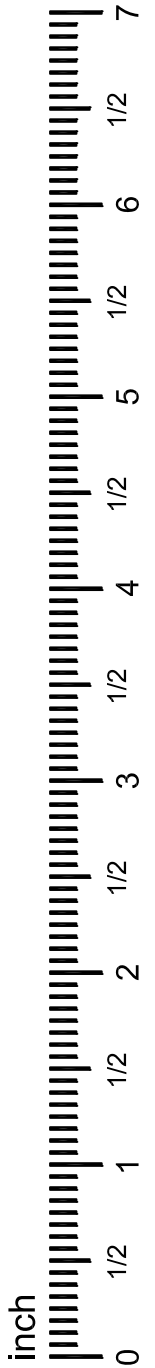

4

Conectar la **B** panel a estructura.

Inserte la cerrojo de combadura **3** en el paneles **E** y luego apretar el cerrojo de combadura **3**.

▲ ADVERTENCIA

Este producto no se moverá hasta que los paneles A (superior y inferior) panel estén unidos.
El incumplimiento de esto puede ocasionar daños y fallas en el producto.

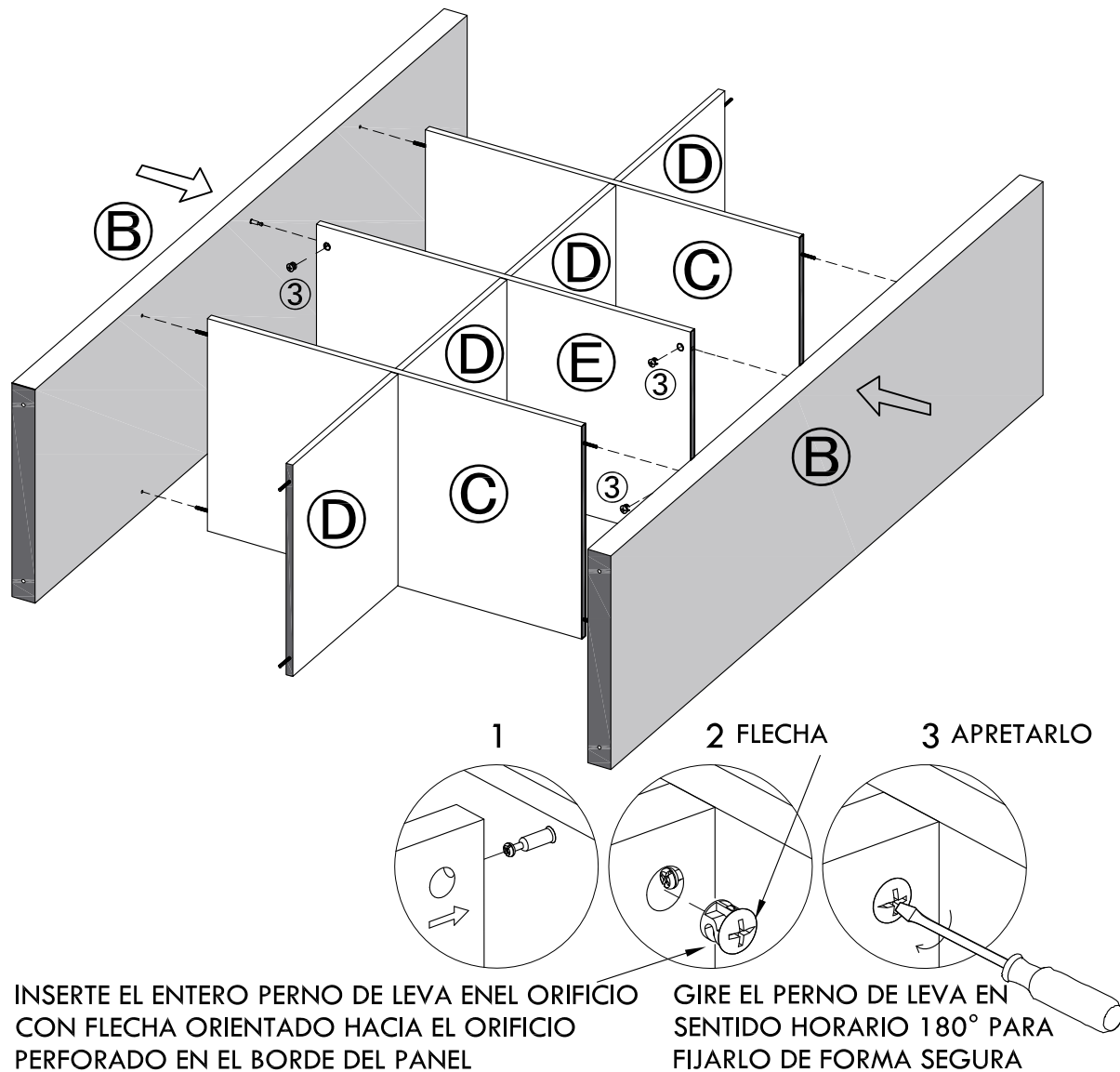

NOTAS ADICIONALES

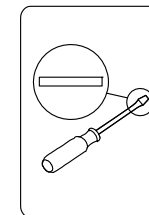

PARTES

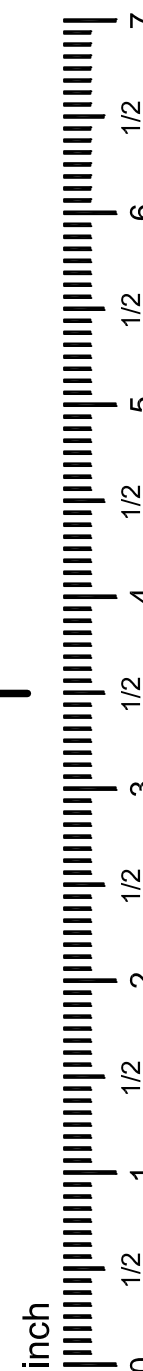

5

Utilice el tornillo ① para fijar el (A) paneles a estructura.

Utilice la tapón ⑥ para cubrir los cabezas el tornillo expuestos en el (A) paneles.

Si la unidad se va a usar verticalmente, sujete la correa de pared (7a) al panel (A) superior. Utilice las piezas (7b) y (7c) para fijar la correa al centro del borde del panel (A) (ubicación marcada con etiqueta naranja).

⚠ ADVERTENCIA

Este producto no se moverá hasta que los paneles A (superior y inferior) panel estén unidos. El incumplimiento de esto puede ocasionar daños y fallas en el producto.

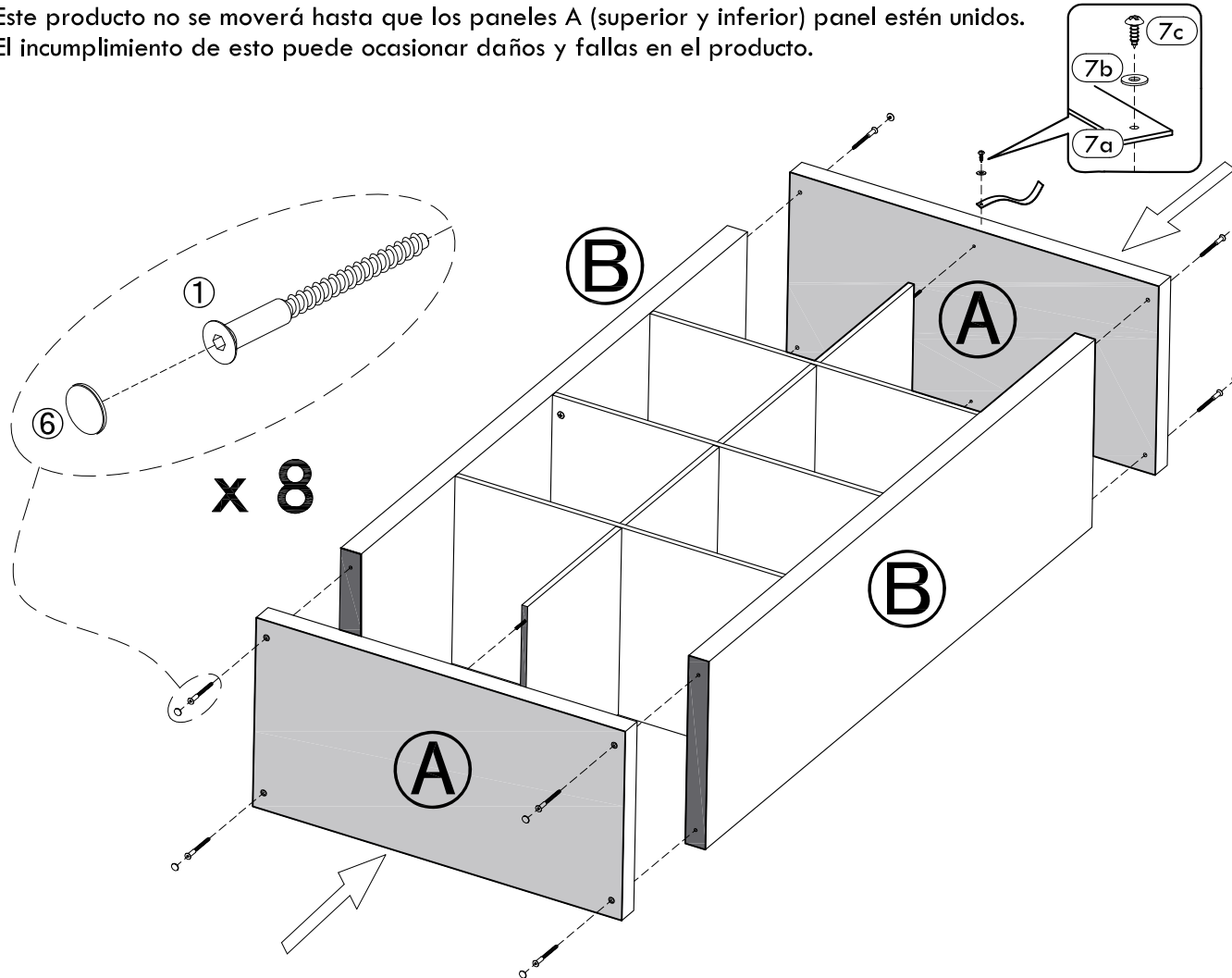

NOTAS ADICIONALES

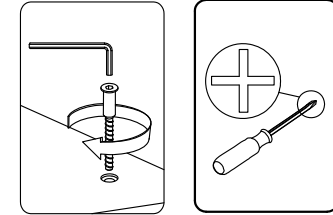

PARTES

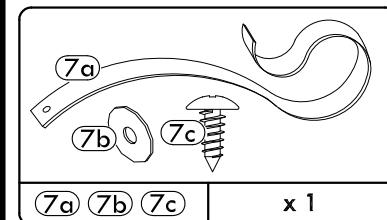
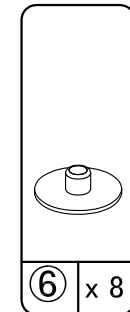
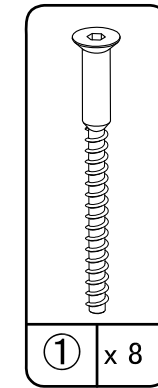

6

Abrochar el cinturón con la pared usando Opción 1 o Opción 2 muestra a continuación.

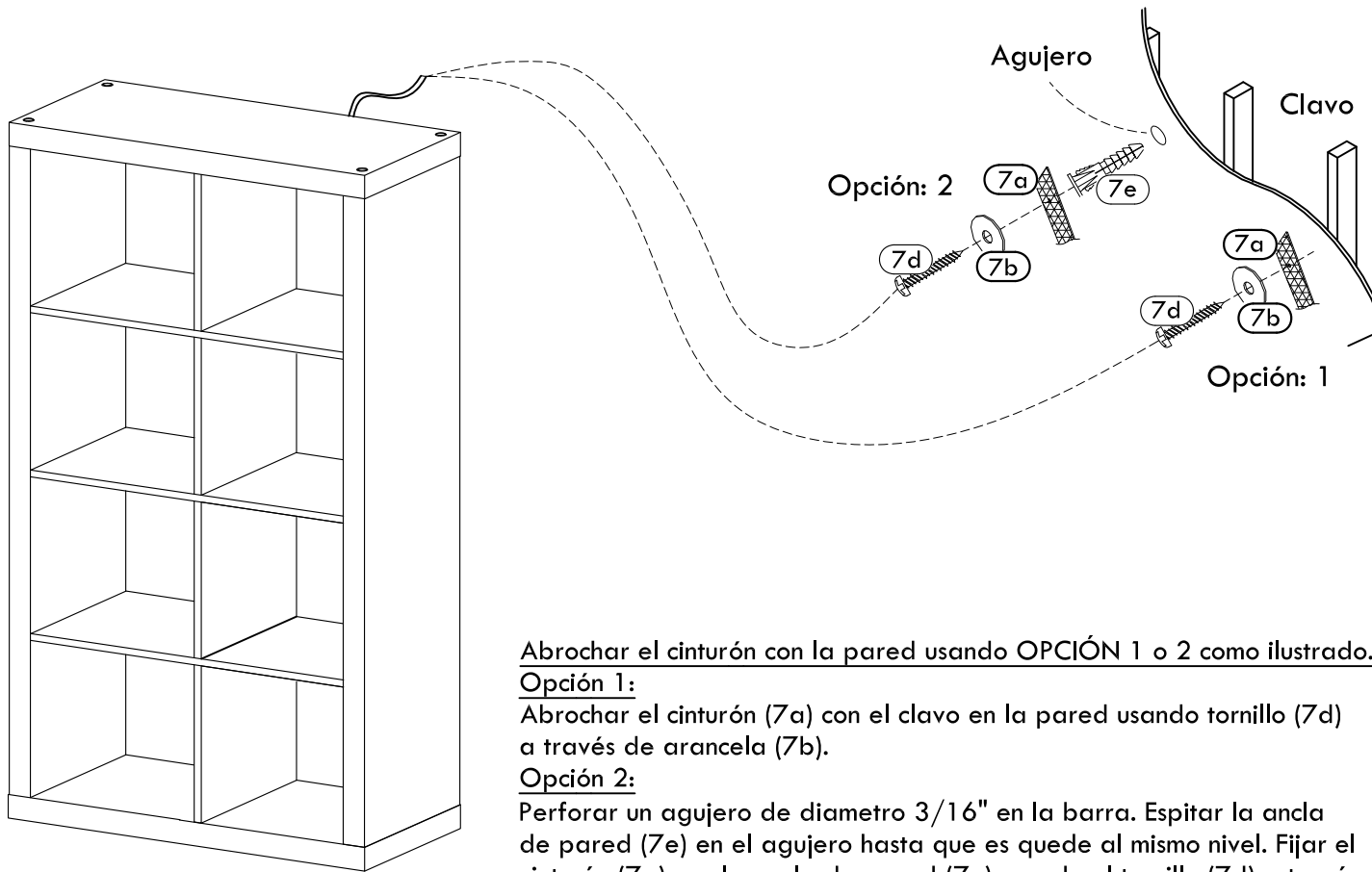

Abrochar el cinturón con la pared usando OPCIÓN 1 o 2 como ilustrado.

Opción 1:

Abrochar el cinturón (7a) con el clavo en la pared usando tornillo (7d) a través de arandela (7b).

Opción 2:

Perforar un agujero de diametro 3/16" en la barra. Espitar la ancla de pared (7e) en el agujero hasta que es quede al mismo nivel. Fijar el cinturón (7a) con la ancla de pared (7e) usando el tornillo (7d) a través de la arandela (7b).

NOTAS ADICIONALES

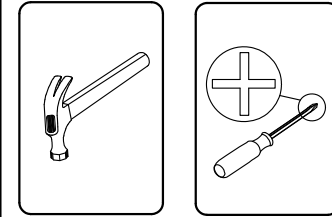

PARTES

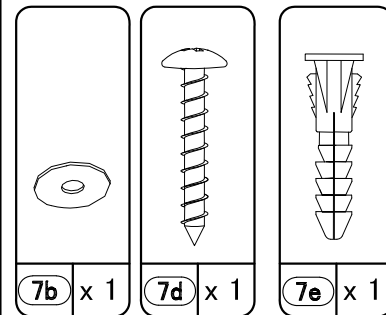

7b x 1

7d x 1

7e x 1

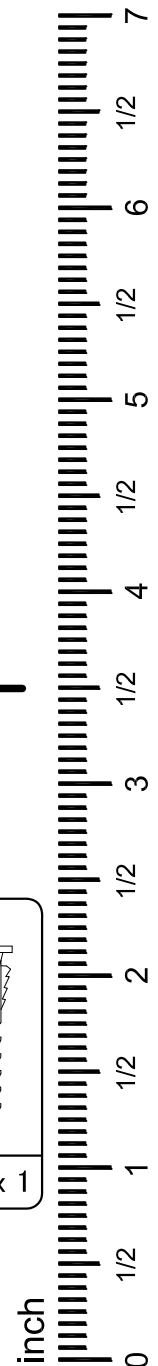

7

Deslice un panel (F) adentro del otro por la ranura como se muestra abajo.

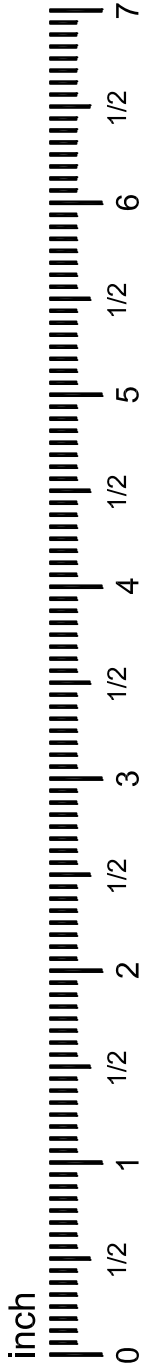
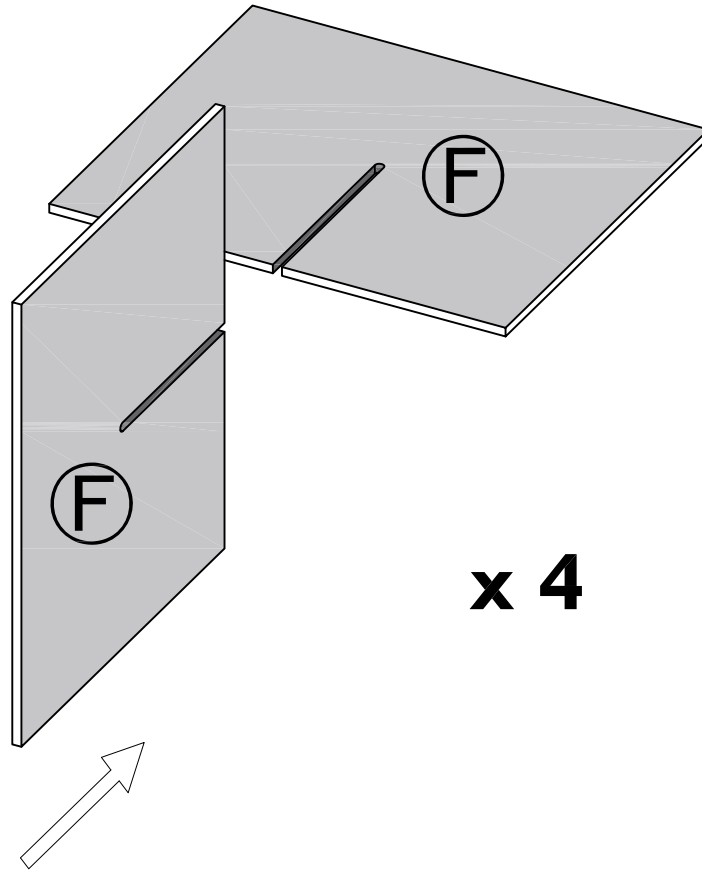

8

Inserte la pieza ensamblada adentro de la estantería que se haya elegido de Almacenamiento de Cubos Better Homes & Gardens.

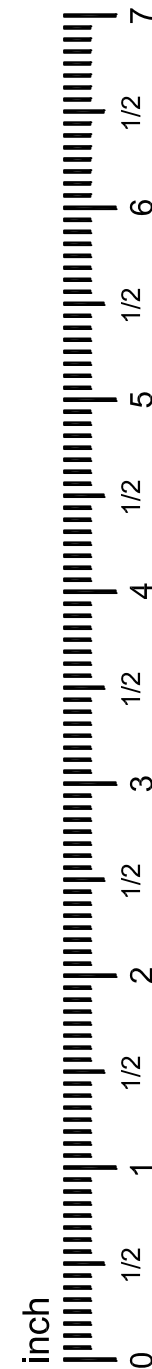
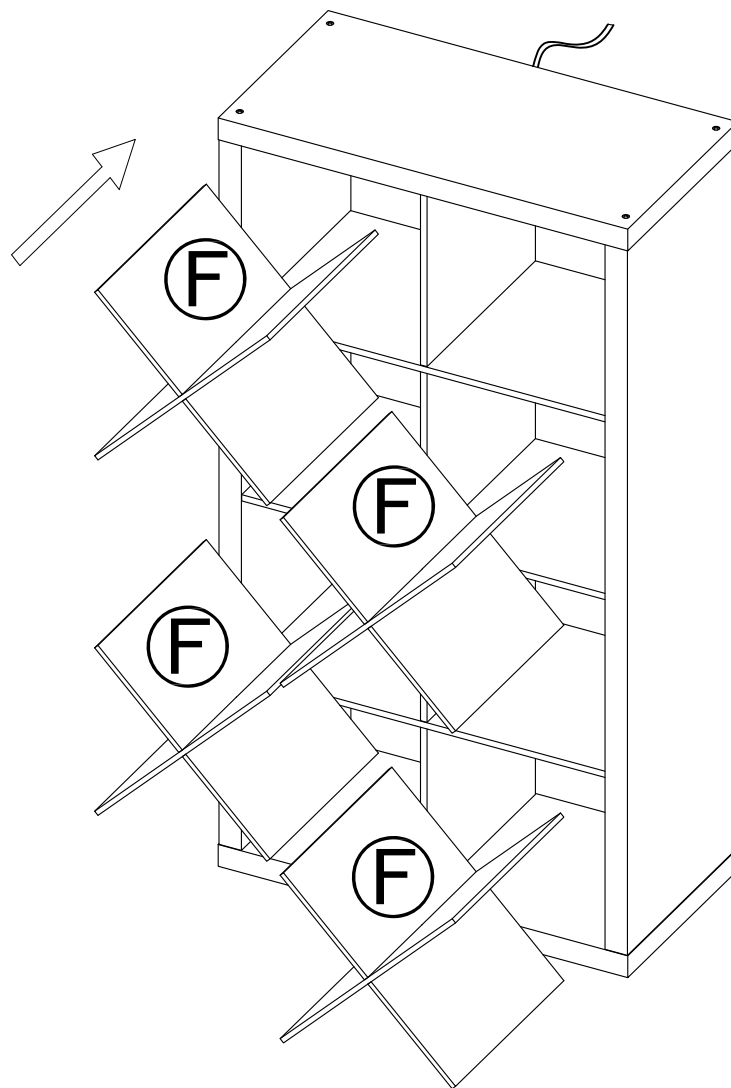

ENHORABUENA, SU ACCESORIO ESTÁ COMPLETO, ¡DISFRUTE Y NO DEJE DE CONTARNOS SU EXPERIENCIA!

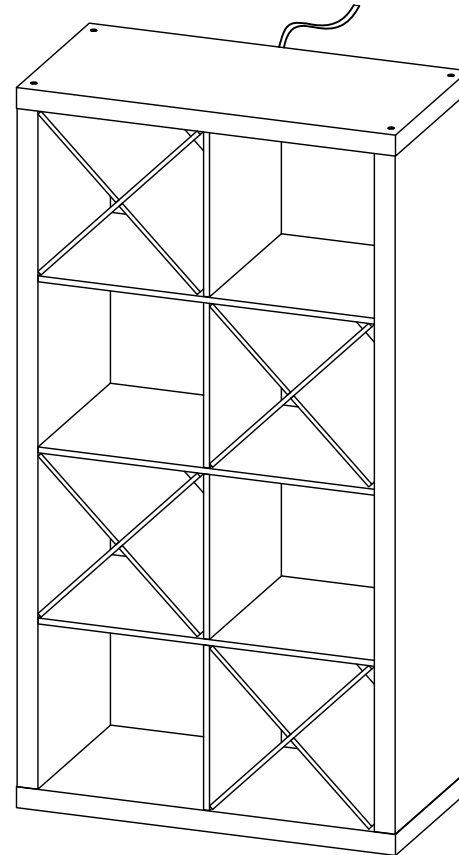

Garantía de Calidad

Si este producto presenta defectos de fabricación o de materiales o se cae bajo usos normales, lo arreglaremos o sustituiremos por hasta (1) año desde la fecha de compra.

Esta garantía te otorga derechos legales específicos y tú también tienes otros derechos que varían de un Estado a otro.

**Por favor de llamarnos para piezas de reemplazo o ayudas: 1-800-729-1569
Lunes - Viernes 9:00 am - 5:00 pm EST**