

BETTER HOMES & GARDENS 3-CUBE ORGANIZER

VENDOR STOCK NUMBERS
BHD036118664007-SOLID BLACK
BHD036118664008-GRAY
BHD036118664009-RUSTIC GRAY

BHD036118664010-WHITE TEXTURE
BHD036118664011-TOBACCO OAK
BHD036118664012-NATURAL

THIS PRODUCT MUST ALWAYS BE MOUNTED TO A WALL OR STUD FOR USE.

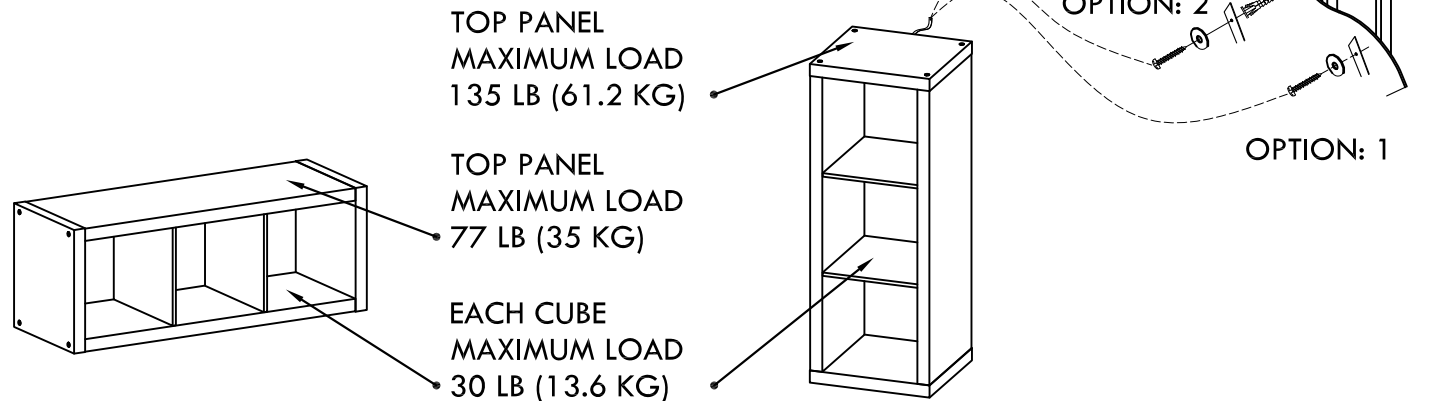

OPTIONAL CONFIGURATION

RECOMMENDED NUMBER OF PEOPLE FOR ASSEMBLY : 1
ESTIMATED ASSEMBLY TIME: 0.5 HOUR

- CALL OUR TOLL FREE NUMBER **1-800-729-1569** FOR FURTHER ASSISTANCE.
- ADDITIONAL PARTS ARE AVAILABLE FOR A FEE.
- THIS INSTRUCTION BOOKLET CONTAINS **IMPORTANT** SAFETY INFORMATION. PLEASE READ AND KEEP FOR FUTURE REFERENCE.
- DO NOT ALLOW CHILDREN TO CLIMB OR PLAY ON THE UNIT.
- CLEAN THE PRODUCT WITH YOUR FAVORITE FURNITURE POLISH AND A SOFT CLOTH.
- DO NOT USE HARSH CHEMICALS OR ABRASIVE CLEANERS.
- MOVE YOUR NEW FURNITURE CAREFULLY WITH TWO PEOPLE. NEVER PUSH OR DRAG THE UNIT.

DO NOT RETURN THE PRODUCT TO THE STORE.
INDIVIDUAL STORES DO NOT STOCK PARTS.
FOR MISSING OR DAMAGED PARTS CALL
1-800-729-1569.
PARTS WILL BE SHIPPED FREE OF CHARGE.

FOR PROMPT, RELIABLE SERVICE, PLEASE HAVE
YOUR ASSEMBLY MANUAL READY.

LOT NUMBER _____
DATE OF PURCHASE ___/___/___



We are available to assist you Monday -Friday
from 9:00 am - 5:00 pm Eastern Standard Time.
1-800-729-1569
USA only.

BETTER HOMES & GARDENS

3-CUBE ORGANIZER

VENDOR STOCK NUMBERS
BHD036118664007-SOLID BLACK
BHD036118664008-GRAY
BHD036118664009-RUSTIC GRAY

BHD036118664010-WHITE TEXTURE
BHD036118664011-TOBACCO OAK
BHD036118664012-NATURAL



BEFORE STARTING

- Read and understand all the steps carefully before starting. If each step is not followed in the correct order the assembly will be difficult and may result in damages.
- Work in a spacious area, preferably on a carpeted surface, near where the unit will be used.
- Make sure all the parts are included. Most boards are labeled with a removable sticker.

Helpful hints

- Call our toll free number if you need assistance. We are available to assist you Monday - Friday from 9:00 am - 5:00 pm Eastern Standard Time.
- **1-800-729-1569** USA only. Or submit a request through our self-service portal at www.huisenfurniture.zendesk.com

TOOLS NEEDED TO ASSEMBLE

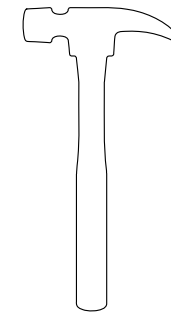
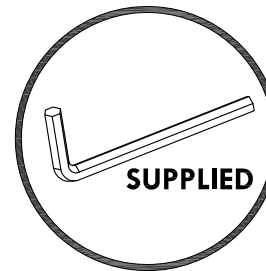

hammer

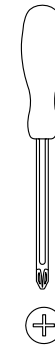

phillips head
screwdriver



DO NOT USE POWER TOOLS TO ASSEMBLE YOUR FURNITURE. POWER TOOLS MAY RESULT IN DAMAGE.



We are available to assist you Monday -Friday from 9:00 am - 5:00 pm Eastern Standard Time.
1-800-729-1569
USA only.

BETTER HOMES & GARDENS

3-CUBE ORGANIZER

VENDOR STOCK NUMBERS
BHD036118664007-SOLID BLACK
BHD036118664008-GRAY
BHD036118664009-RUSTIC GRAY

BHD036118664010-WHITE TEXTURE
BHD036118664011-TOBACCO OAK
BHD036118664012-NATURAL

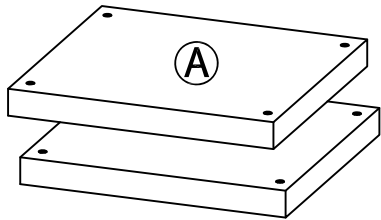

Top/bottom panel
(Qty: 2)

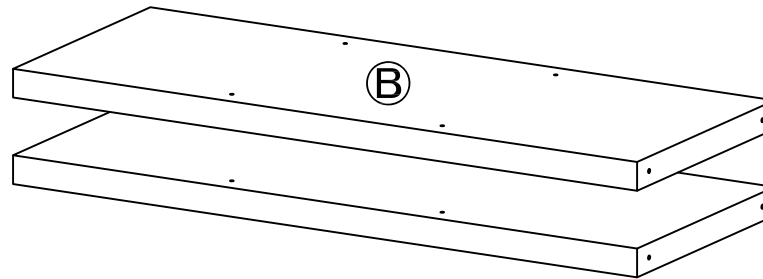

Side panel
(Qty: 2)

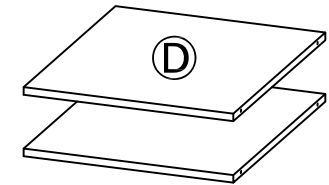

Middle shelf
(Qty: 2)

VERIFY THAT ALL PARTS ARE PRESENT BEFORE BEGINNING



We are available to assist you Monday -Friday
from 9:00 am - 5:00 pm Eastern Standard Time.
1-800-729-1569
USA only.

BETTER HOMES & GARDENS

3-CUBE ORGANIZER

VENDOR STOCK NUMBERS
 BHD036118664007-SOLID BLACK
 BHD036118664008-GRAY
 BHD036118664009-RUSTIC GRAY

BHD036118664010-WHITE TEXTURE
 BHD036118664011-TOBACCO OAK
 BHD036118664012-NATURAL

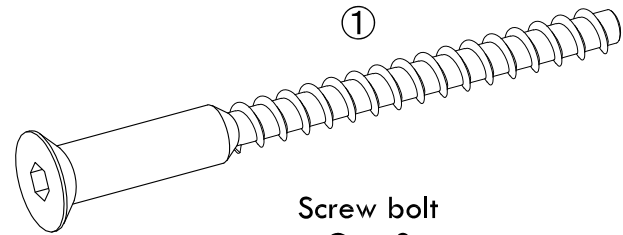

①
 Screw bolt
 Qty: 8

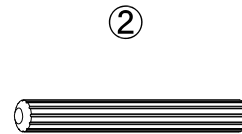

②
 Plastic dowel
 Qty: 8

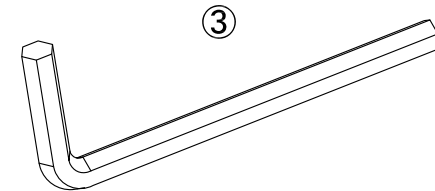

③
 Allen key
 Qty: 1

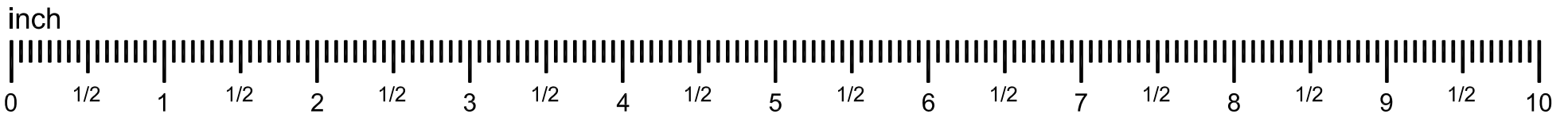

④
 Cap
 Qty: 8+1 Extra

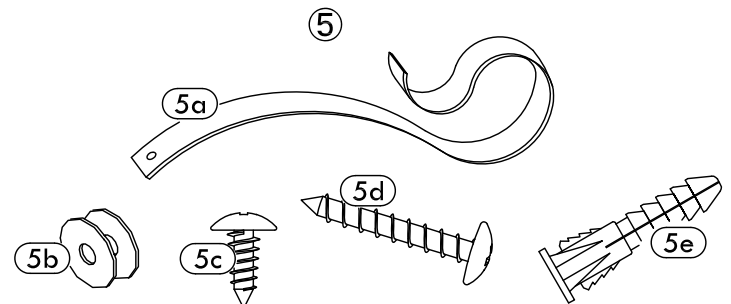

⑤
 Safety strap kit
 Qty: 1

VERIFY THAT ALL PARTS ARE PRESENT BEFORE BEGINNING



We are available to assist you Monday -Friday
 from 9:00 am - 5:00 pm Eastern Standard Time.
1-800-729-1569
 USA only.

1

Insert plastic dowels ② into ① panels.
Push dowels into predrilled holes leaving 1 1/4" exposed.

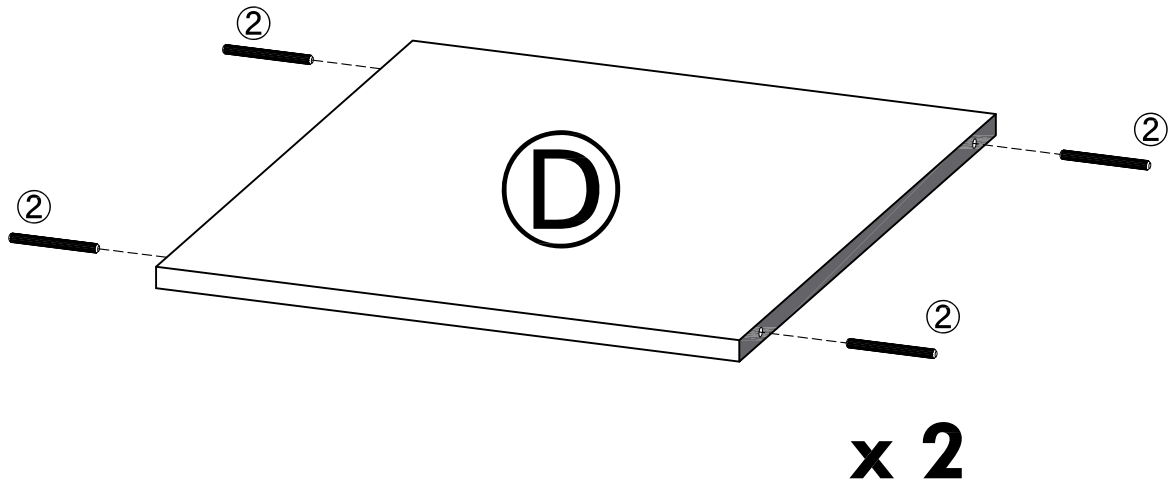

ADDITIONAL NOTES

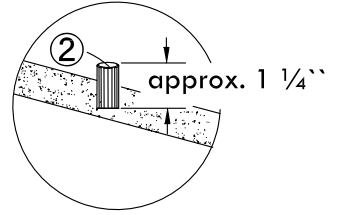

PARTS

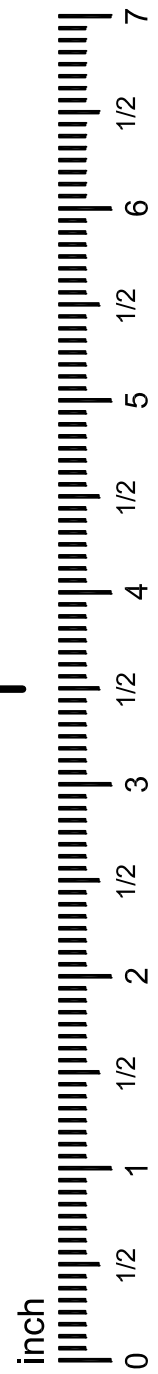
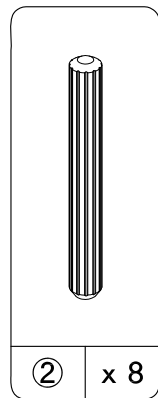

2

Connect ④ panels between side panels ③.

▲ WARNING

Do not move this product until A (top/bottom) panels are attached.
Failure to follow this could result in product damage and failure.

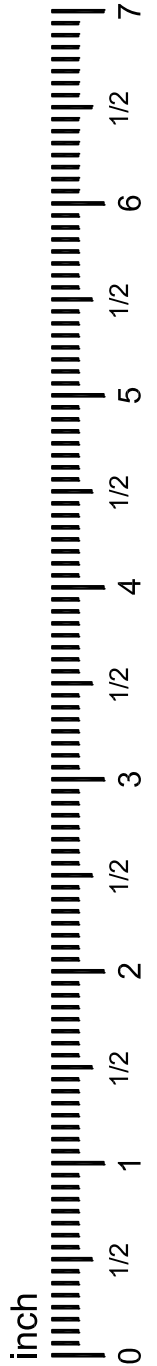
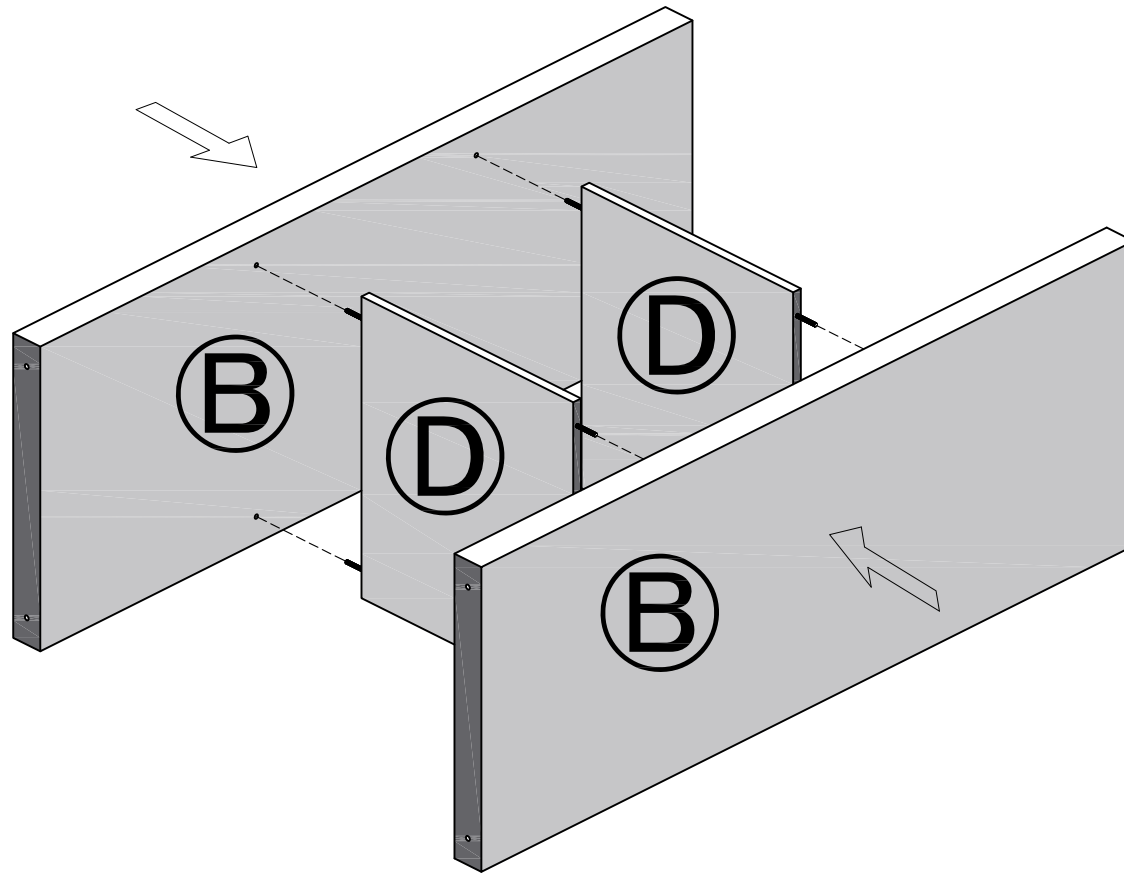

3

Use screw bolts ① & allen key to attach top/bottom panels ①A to structure.
Use caps ④ to cover exposed screw heads in ①A panels.
if unit is going to be used vertically, center wall strap ⑤a in the edge of top panel ①A and attach using ⑤b & ⑤c.

▲ WARNING

Do not move this product until A (top/bottom) panels are attached.
Failure to follow this could result in product damage and failure.

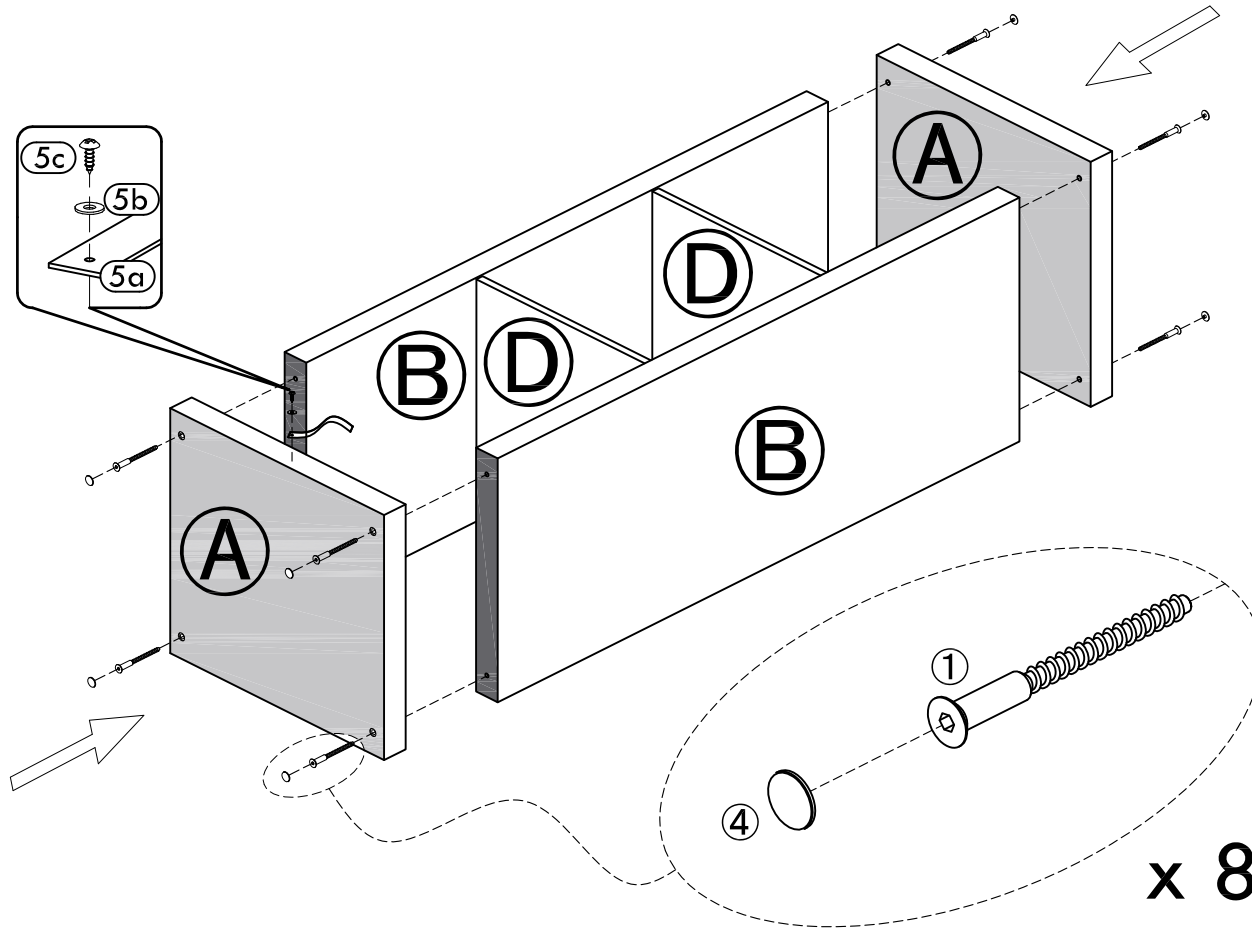

ADDITIONAL NOTES

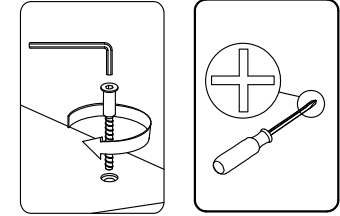

PARTS

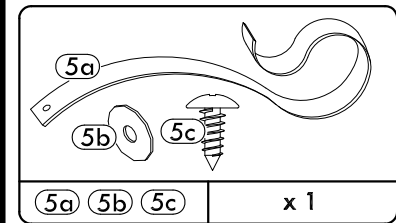
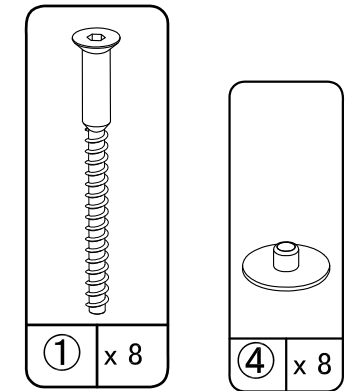

inch



4

Fasten safety strap to wall using Option 1 or Option 2 as shown below.

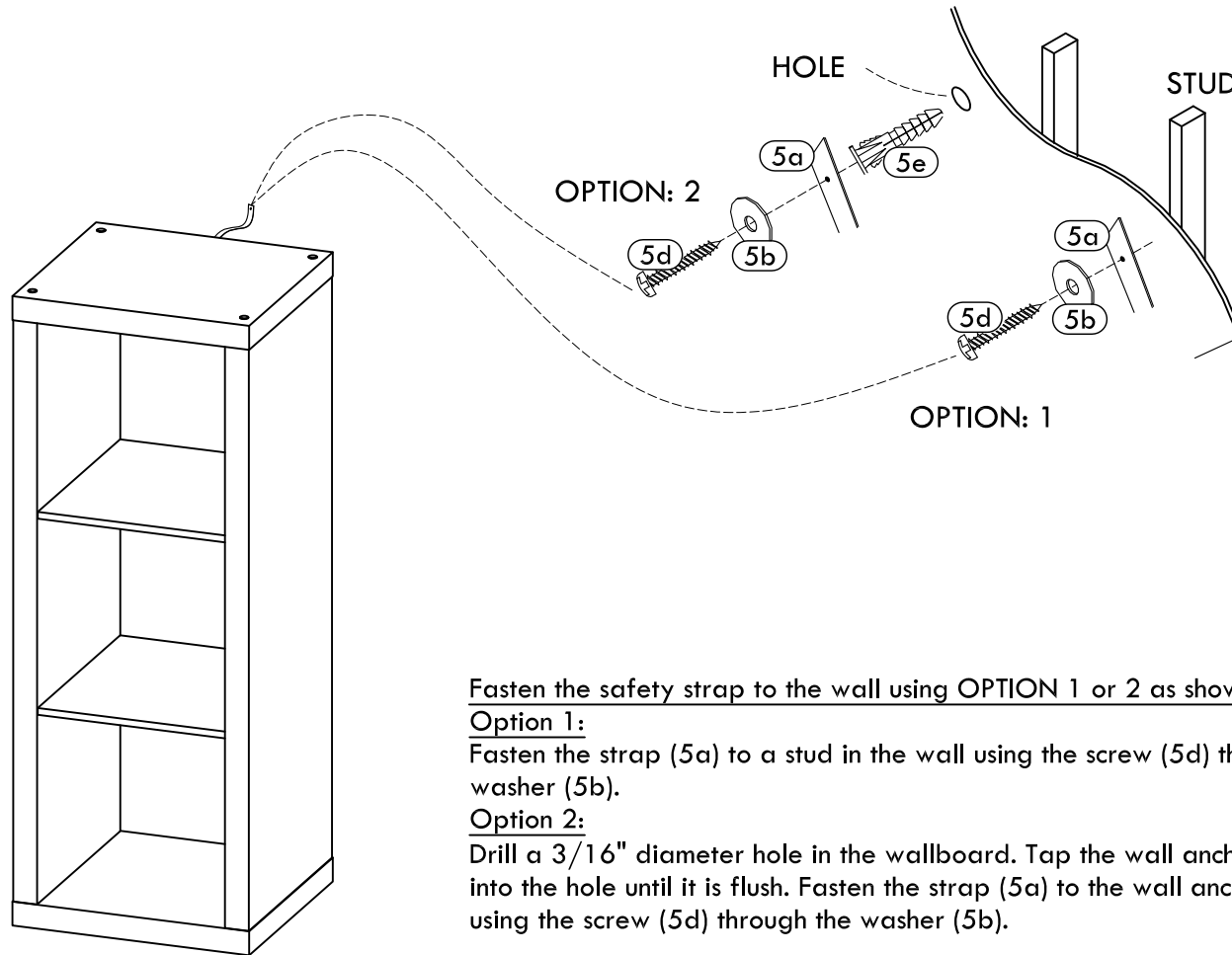

Fasten the safety strap to the wall using **OPTION 1** or **2** as shown.

Option 1:

Fasten the strap (5a) to a stud in the wall using the screw (5d) through washer (5b).

Option 2:

Drill a 3/16" diameter hole in the wallboard. Tap the wall anchor (5e) into the hole until it is flush. Fasten the strap (5a) to the wall anchor (5e) using the screw (5d) through the washer (5b).

ADDITIONAL NOTES

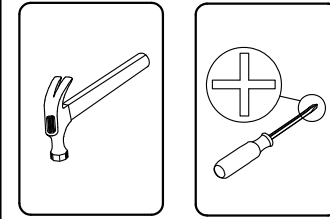

PARTS

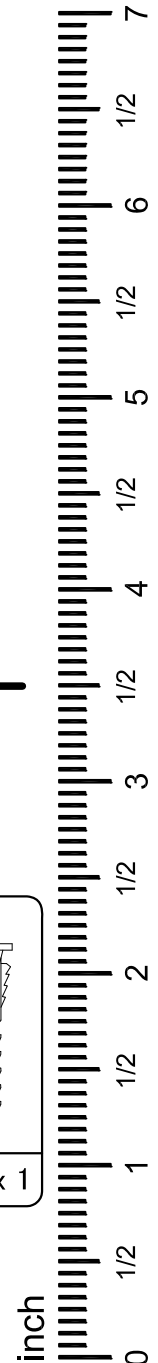
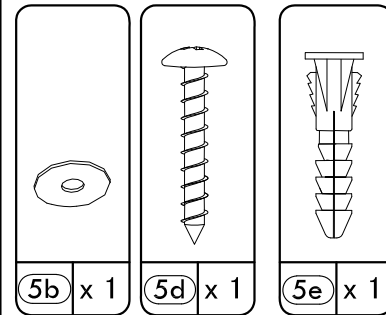

CONGRATULATIONS, YOUR UNIT IS COMPLETE, PLEASE ENJOY AND BE SURE TO TELL US ABOUT YOUR EXPERIENCE!

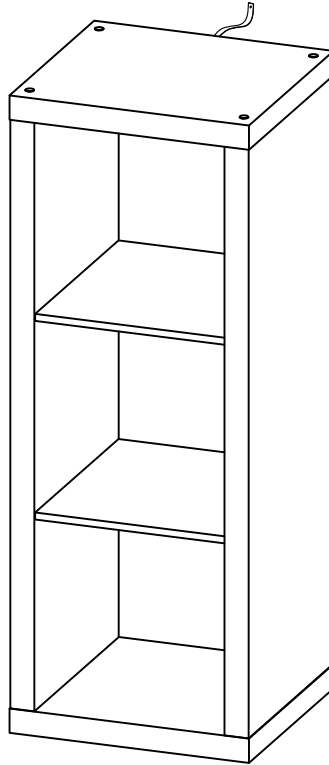

Quality Guarantee

Should this product be defective in workmanship or materials or fail under normal use, we will repair or replace it for up to (1) year from date of purchase.

This warranty gives you specific legal rights and you may also have other rights which vary from State to State.

**Please call for replacement parts or assistance: 1-800-729-1569
Monday - Friday 9:00 am - 5:00 pm EST**

BETTER HOMES & GARDENS ORGANIZADOR DE 3 CUBOS

NÚMERO DE STOCK DEL VENDEDOR
BHD036118664007-NEGRO SÓLIDO
BHD036118664008-GRIS
BHD036118664009-GRIS RÚSTICO

BHD036118664010-TEXTURA BLANCO
BHD036118664011-ROBLE TABACO
BHD036118664012-NATURAL

ESTE PRODUCTO DEBE MONTARSE SIEMPRE EN
UNA PARED O EN UN EXTREMO PARA SU USO.

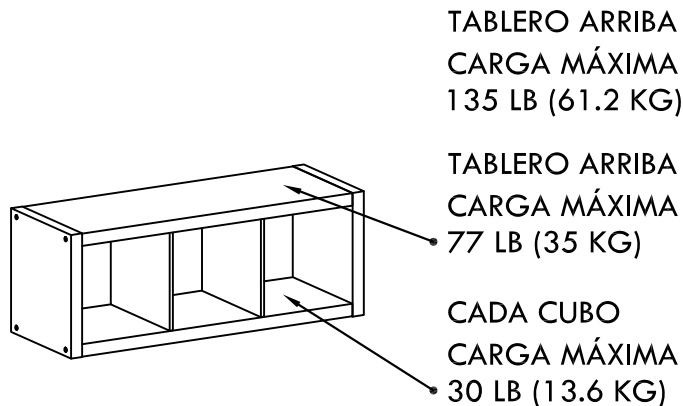

CONFIGURACIÓN OPCIONAL

NÚMERO DE PERSONAS RECOMENDADO PARA EL ENSAMBLAJE: 1
TIEMPO ESTIMADO DE ENSAMBLAJE: 0.5 HORA

- LLAME A NUESTRO NÚMERO GRATUITO **1-800-729-1569** PARA OBTENER MÁS AYUDA.
- PIEZAS ADICIONALES ESTÁN DISPONIBLES POR UNA TARIFA.
- ESTE MANUAL DE INSTRUCCIÓN CONTIENE INFORMACIÓN **IMPORTANTE** DE SEGURIDAD. POR FAVOR DE LEER Y GUARDAR PARA FUTURAS REFERENCIAS.
- NO DEJAR A LOS NIÑOS SUBIR O JUGAR SOBRE LA UNIDAD.
- LIMPIAR EL PRODUCTO CON TU PULIDOR FAVORITE DE MUEBLE Y UN TRAPO BLANDO.
- NO USAR QUÍMICOS FUERTES O PRODUCTO DE LIMPIEZA ABRASIVO.
- MUEVA SUS NUEVOS MUEBLES CUIDADOSAMENTE CON DOS PERSONAS, NUNCA EMPUJE O ARRASTRE LA UNIDAD.

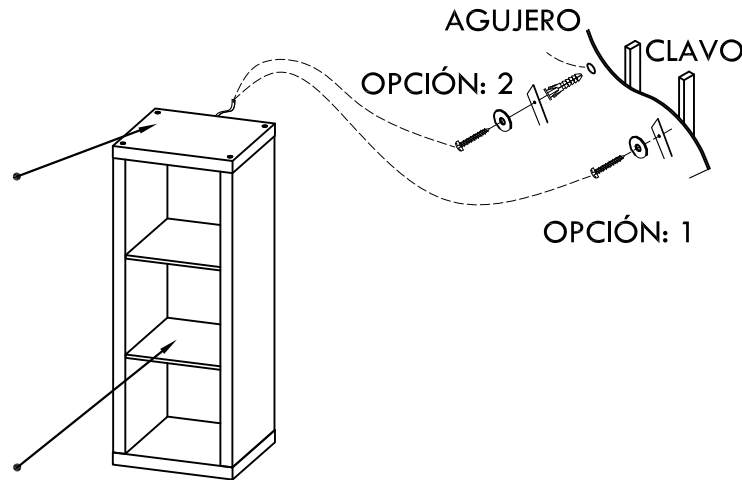

NO DEVOLVER EL PRODUCTO A LA TIENDA.
TIENDAS INDIVIDUALES NO RESERVAN PIEZAS.
PARA PIEZAS PERDIDAS O DAÑADAS LLAME AL
1-800-729-1569.
PARTES SERÁN ENVIADOS DE FORMA GRATUITA.
PARA UN SERVICIO RÁPIDO Y CONFIABLE, POR
FAVOR DE TENER A MANO EL MANUAL DE
ENSAMBLAJE.

NÚMERO DE PARTIDA _____
FECHA DE COMPRA ___/___/___



Estamos disponibles para ayudarlo de Lunes - Viernes
de 9:00 am - 5:00 pm Hora de la Zona Este.
1-800-729-1569
Sólo E.E.U.U.

BETTER HOMES & GARDENS ORGANIZADOR DE 3 CUBOS

NÚMERO DE STOCK DEL VENDEDOR
BHD036118664007-NEGRO SÓLIDO
BHD036118664008-GRIS
BHD036118664009-GRIS RÚSTICO

BHD036118664010-TEXTURA BLANCO
BHD036118664011-ROBLE TABACO
BHD036118664012-NATURAL



ANTES DE COMENZAR

- Leer y entender todos los pasos cuidadosamente antes de comenzar. Si no se sigue cada paso en el orden correcto, el montaje será difícil y puede ocasionar daños.
- Trabajar en una zona amplia, mejor sobre la alfombra, cerca del sitio donde la unidad se utiliza.
- Asegurarse de que todas las piezas estén incluidos. La mayoría de los tableros están etiquetados con una pegatina removible.

Consejos útiles

- Llamar a nuestro número gratis para ayuda. Estamos disponibles para ayudarlo de lunes - Viernes de 9:00 am - 5:00 pm hora de la zona este.
- **1-800-729-1569** Sólo E.E.U.U.
O haga una solicitud a través de nuestro portal de autoservicio en www.huisenfurniture.zendesk.com

HERRAMIENTAS NECESARIAS PARA ENSAMBLAR

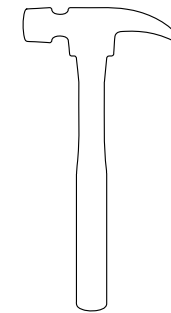
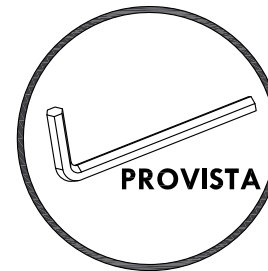

martillo

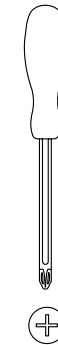

destornillador de
cabeza phillips



**NO UTILICE HERRAMIENTAS ELÉCTRICAS
PARA MONTAR SUS MUEBLES.
HERRAMIENTAS ELÉCTRICAS PUEDEN
PROVOCAR DAÑOS.**



Estamos disponibles para ayudarlo de Lunes - Viernes
de 9:00 am - 5:00 pm Hora de la Zona Este.
1-800-729-1569
Sólo E.E.U.U.

BETTER HOMES & GARDENS

ORGANIZADOR DE 3 CUBOS

NÚMERO DE STOCK DEL VENDEDOR
BHD036118664007-NEGRO SÓLIDO
BHD036118664008-GRIS
BHD036118664009-GRIS RÚSTICO

BHD036118664010-TEXTURA BLANCO
BHD036118664011-ROBLE TABACO
BHD036118664012-NATURAL

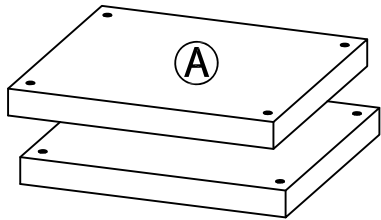

Barra arriba/abajo
(Cantidad: 2)

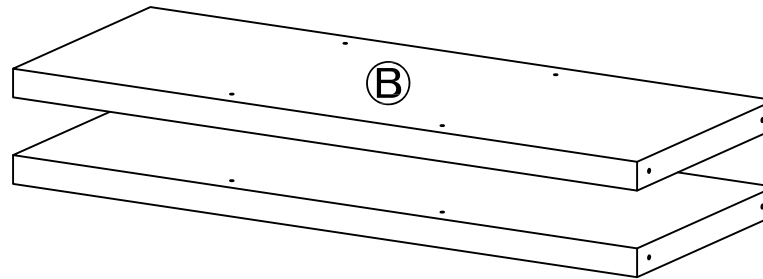

Barra lateral
(Cantidad: 2)

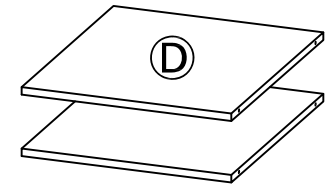

Estante del medio
(Cantidad: 2)

VERIFIQUE QUE TODAS LAS PIEZAS ESTÉN EN LA LISTA ANTES DE COMENZAR



Estamos disponibles para ayudarlo de Lunes - Viernes de 9:00 am - 5:00 pm Hora de la Zona Este.
1-800-729-1569
Sólo E.E.U.U.

BETTER HOMES & GARDENS ORGANIZADOR DE 3 CUBOS

NÚMERO DE STOCK DEL VENDEDOR
 BHD036118664007-NEGRO SÓLIDO
 BHD036118664008-GRIS
 BHD036118664009-GRIS RÚSTICO

BHD036118664010-TEXTURA BLANCO
 BHD036118664011-ROBLE TABACO
 BHD036118664012-NATURAL

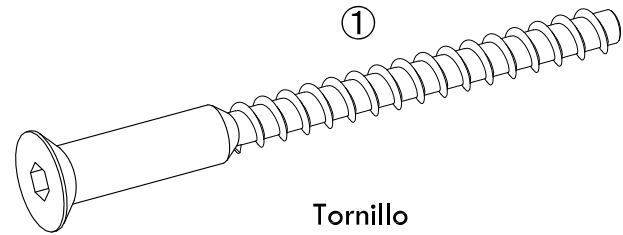

①
 Tornillo
 Cantidad: 8

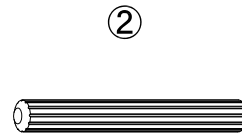

②
 Clavija de plástico
 Cantidad: 8

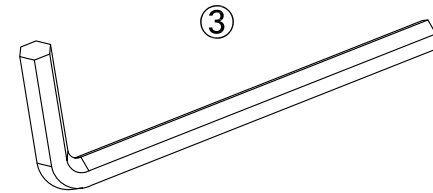

③
 Llave allen
 Cantidad: 1

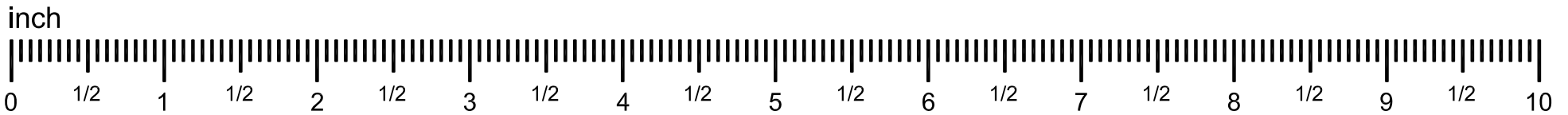

④
 Tapón
 Cantidad: 8+1 Extra

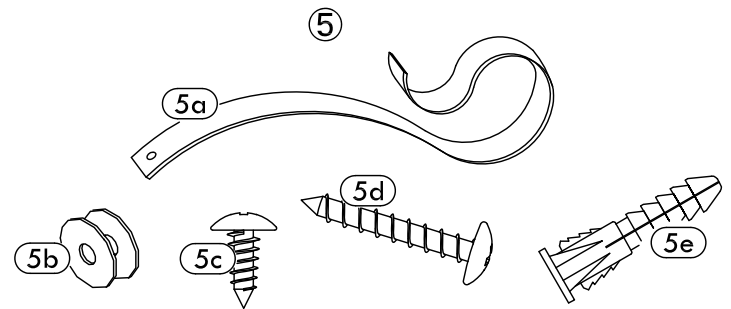

⑤
 Cinturón
 Cantidad: 1

VERIFIQUE QUE TODAS LAS PIEZAS ESTÉN EN LA LISTA ANTES DE COMENZAR



Estamos disponibles para ayudarlo de Lunes - Viernes de 9:00 am - 5:00 pm Hora de la Zona Este.
1-800-729-1569
 Sólo E.E.U.U.

1

Insertar clavijas de plástico ② en panel ①.
Empuje los tapones en el agujeros predrillado dejando 1 1/4" expuesto.

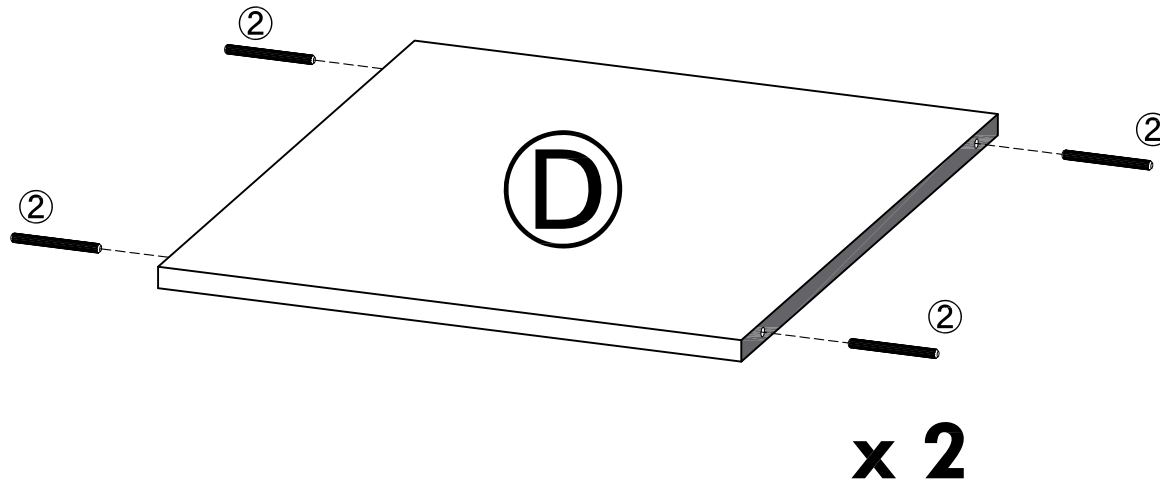

NOTAS ADICIONALES

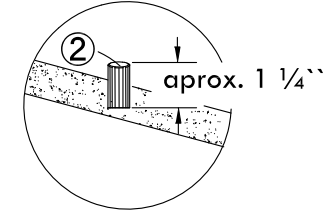

PARTES

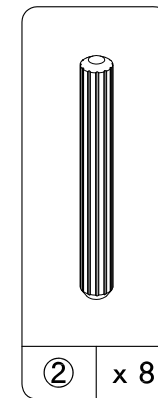

② x 8

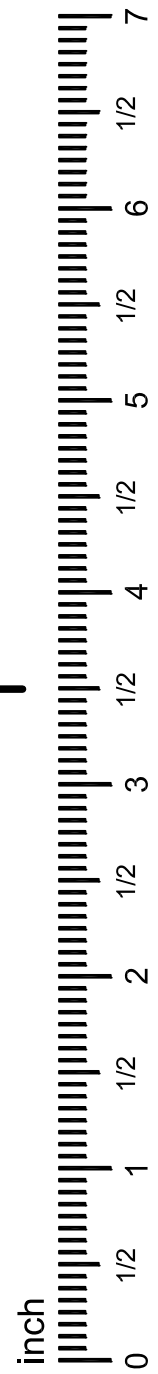

2

Conectar la ① panel entre barra lateral ②.

▲ ADVERTENCIA

Este producto no se moverá hasta que los paneles A (superior y inferior) panel estén unidos.
El incumplimiento de esto puede ocasionar daños y fallas en el producto.

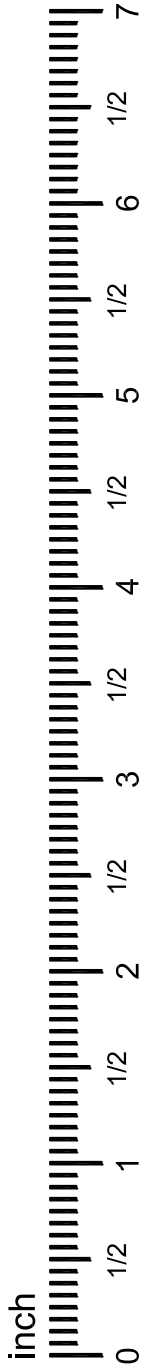
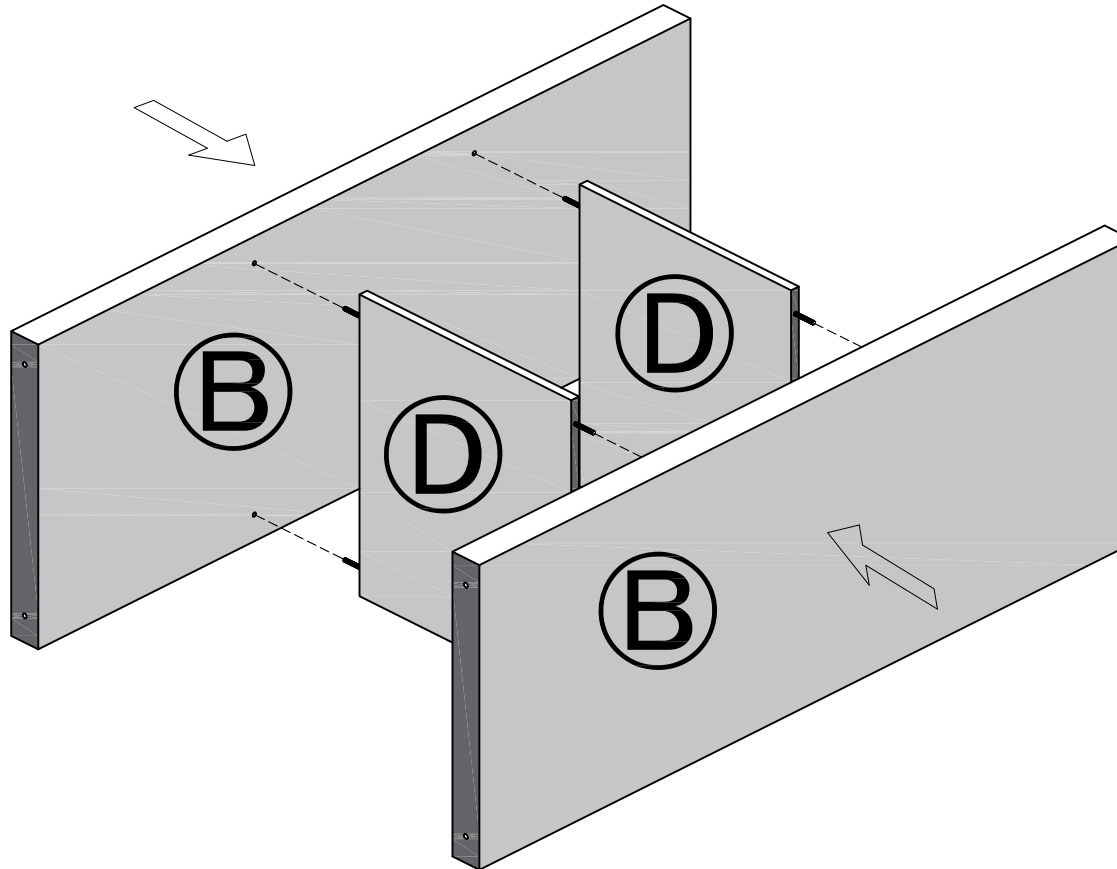

3

Utilice el tornillo ① y llave allen para fijar el panel superior/inferior ① a estructura.
Utilice la tapón ④ para cubrir los cabezas el tornillo expuestos en el ① paneles.
Si el conjunto se va a usar verticalmente, Coloque la correa de pared central ⑤a en el borde del panel superior ① y fija usando ⑤b y ⑤c.

▲ ADVERTENCIA

Este producto no se moverá hasta que los paneles A (superior y inferior) panel estén unidos.
El incumplimiento de esto puede ocasionar daños y fallas en el producto.

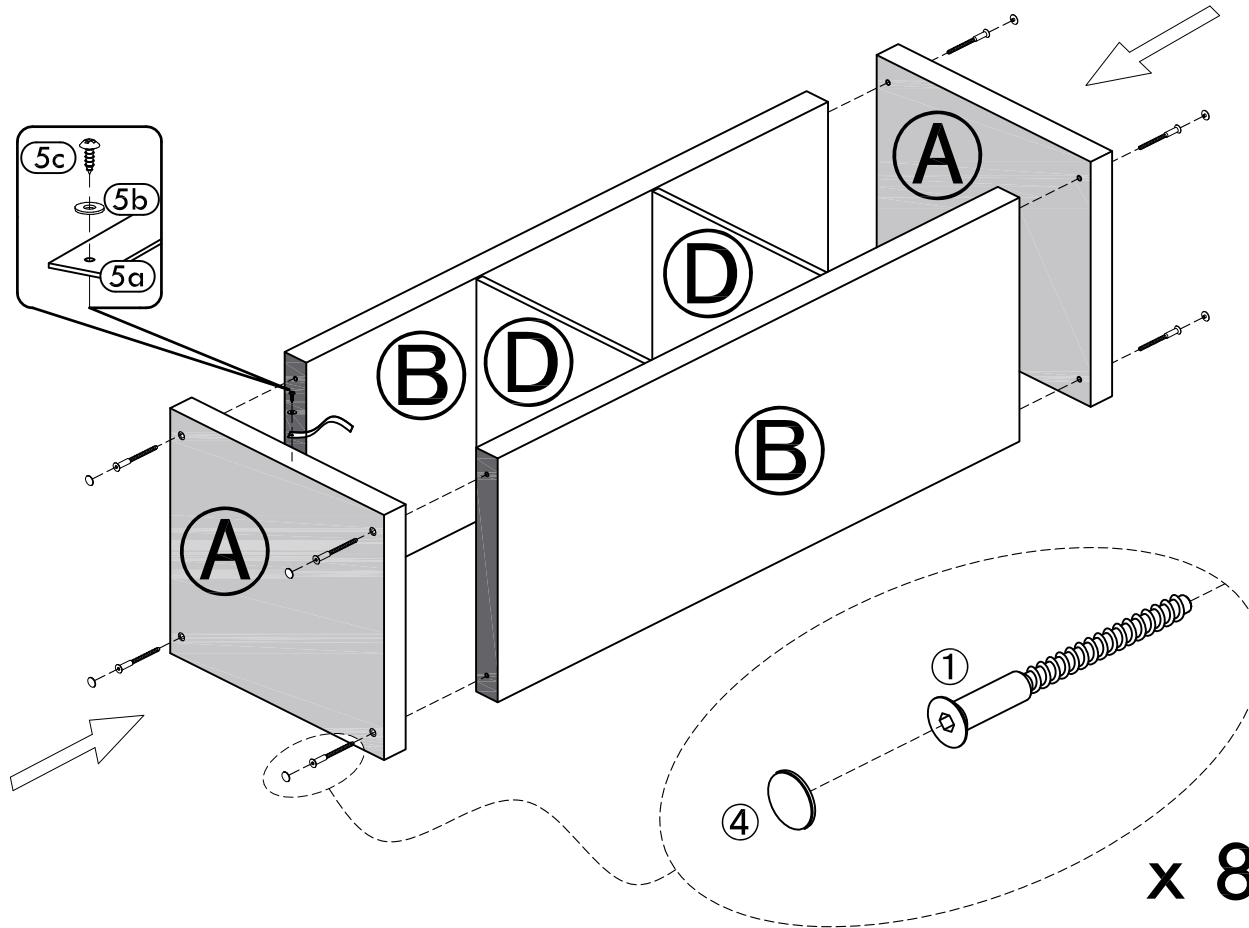

NOTAS ADICIONALES

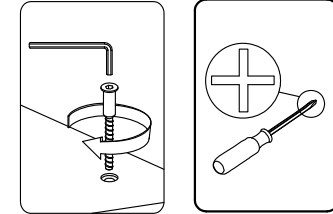

PARTES

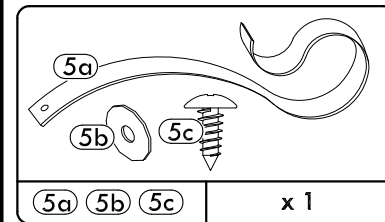
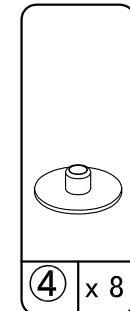
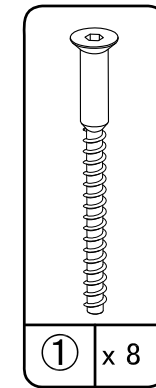

inch

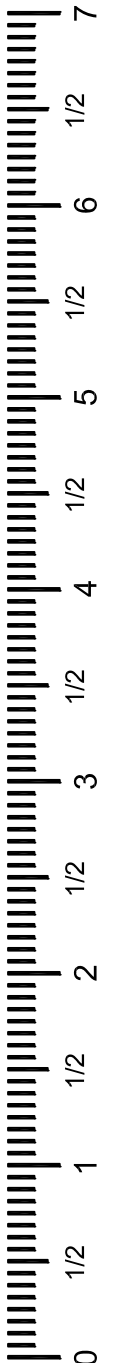

4

Abrochar el cinturón con la pared usando Opción 1 o Opción 2 muestra a continuación.

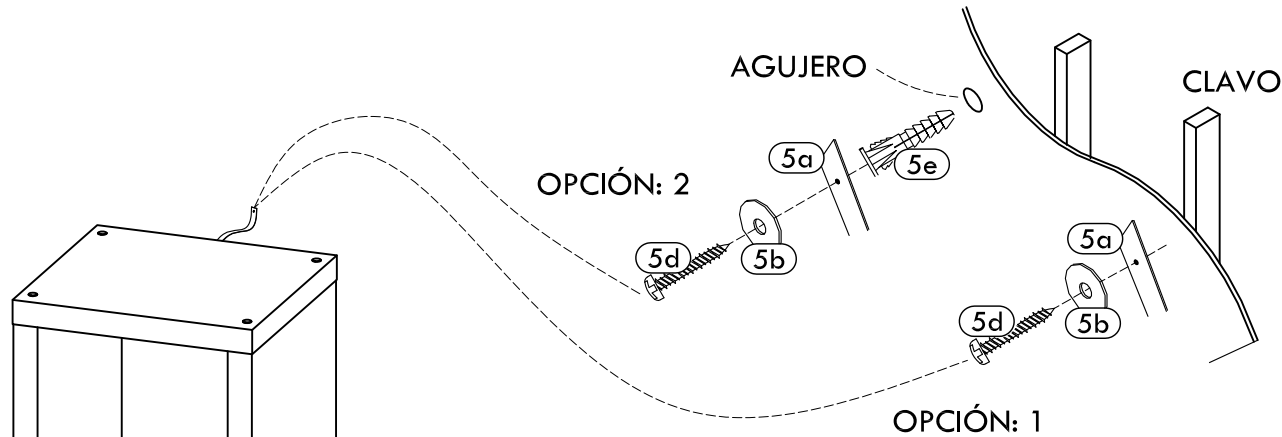

Abrochar el cinturón con la pared usando OPCIÓN 1 o 2 como ilustrado.

Opción 1:

Abrochar el cinturón (5a) con el clavo en la pared usando tornillo (5d) a través de arandela (5b).

Opción 2:

Perforar un agujero de diámetro 3/16" en la barra. Espitar la ancla de pared (5e) en el agujero hasta que es quede al mismo nivel. Fijar el cinturón (5a) con la ancla de pared (5e) usando el tornillo (5d) a través de la arandela (5b).

NOTAS ADICIONALES

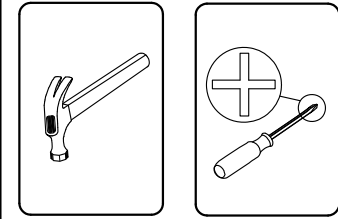

PARTES

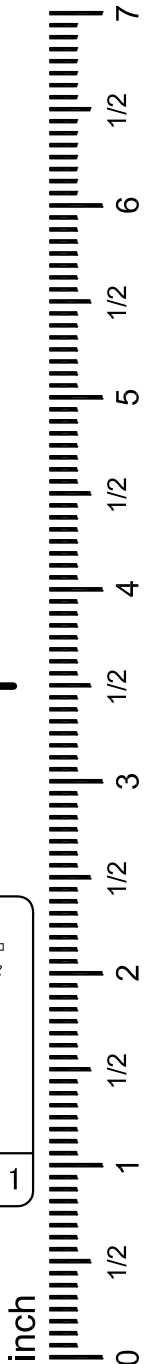
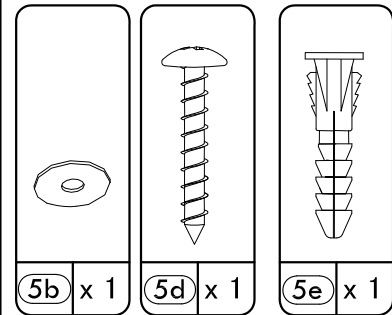

ENHORABUENA, SU ACCESORIO ESTÁ COMPLETO, ¡DISFRUTE Y NO DEJE DE CONTARNOS SU EXPERIENCIA!

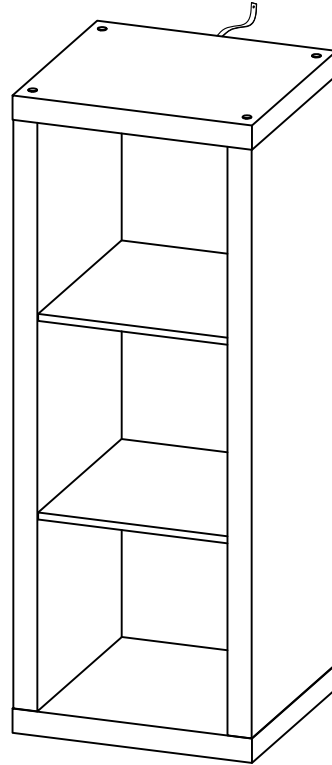

Garantía de Calidad

Si este producto presenta defectos de fabricación o de materiales o se cae bajo usos normales, lo arreglaremos o sustituiremos por hasta (1) año desde la fecha de compra.

Esta garantía te otorga derechos legales específicos y tú también tienes otros derechos que varían de un Estado a otro.

**Por favor de llamarnos para piezas de reemplazo o ayudas: 1-800-729-1569
Lunes - Viernes 9:00 am - 5:00 pm EST**