

BETTER HOMES & GARDENS ADJUSTABLE SHELF CUBE STORAGE

VENDOR STOCK NUMBERS
BH5336278612102-LIGHT HONEY
BH5336278612103-CHARCOAL

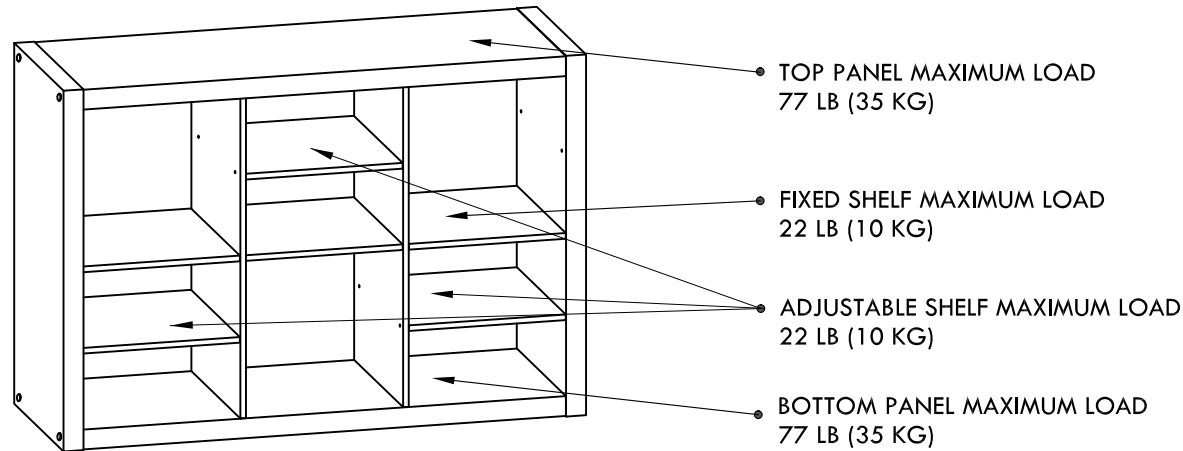

RECOMMENDED NUMBER OF PEOPLE FOR ASSEMBLY: 1
ESTIMATED ASSEMBLY TIME: 1 HOUR

- CALL OUR TOLL FREE NUMBER **1-800-729-1569** FOR FURTHER ASSISTANCE.
- ADDITIONAL PARTS ARE AVAILABLE FOR A FEE.
- THIS INSTRUCTION BOOKLET CONTAINS **IMPORTANT** SAFETY INFORMATION. PLEASE READ AND KEEP FOR FUTURE REFERENCE.
- DO NOT ALLOW CHILDREN TO CLIMB OR PLAY ON THE UNIT.
- CLEAN THE PRODUCT WITH YOUR FAVORITE FURNITURE POLISH AND A SOFT CLOTH.
- DO NOT USE HARSH CHEMICALS OR ABRASIVE CLEANERS.
- MOVE YOUR NEW FURNITURE CAREFULLY WITH TWO PEOPLE. NEVER PUSH OR DRAG THE UNIT.

**DO NOT RETURN THE PRODUCT TO THE STORE.
INDIVIDUAL STORES DO NOT STOCK PARTS.
FOR MISSING OR DAMAGED PARTS CALL
1-800-729-1569.
PARTS WILL BE SHIPPED FREE OF CHARGE.**

**FOR PROMPT, RELIABLE SERVICE, PLEASE HAVE
YOUR ASSEMBLY MANUAL READY.**

LOT NUMBER _____
DATE OF PURCHASE ___/___/___

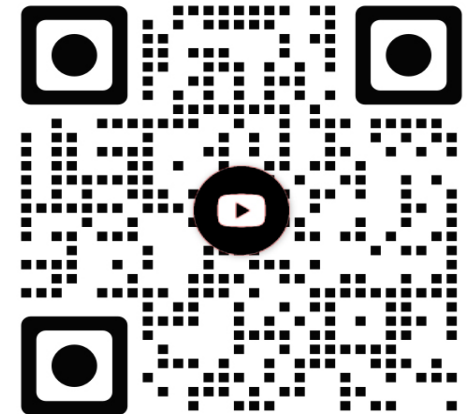

Open your camera and scan the QR code
above for a video assembly guide

Megaprima Home Pte Ltd.
Designed in the USA
Made in Malaysia



We are available to assist you Monday -Friday
from 9:00 am - 5:00 pm Eastern Standard Time.
1-800-729-1569
USA only.

BETTER HOMES & GARDENS ADJUSTABLE SHELF CUBE STORAGE

VENDOR STOCK NUMBERS
BH5336278612102-LIGHT HONEY
BH5336278612103-CHARCOAL



BEFORE STARTING

- Read and understand all the steps carefully before starting. If each step is not followed in the correct order the assembly will be difficult and may result in damages.
- Work in a spacious area, preferably on a carpeted surface, near where the unit will be used.
- Make sure all the parts are included. Most boards are labeled with a removable sticker.

Helpful hints

- Call our toll free number if you need assistance. We are available to assist you Monday - Friday from 9:00 am - 5:00 pm Eastern Standard Time.
- **1-800-729-1569** USA only. Or submit a request through our self-service portal at www.huisenfurniture.zendesk.com

TOOLS NEEDED TO ASSEMBLE

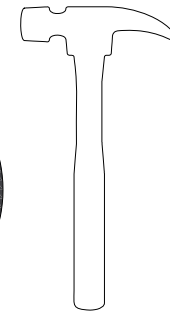
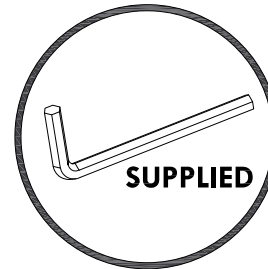

hammer



Phillips head screwdriver



DO NOT USE POWER TOOLS TO ASSEMBLE YOUR FURNITURE. POWER TOOLS MAY RESULT IN DAMAGE.

Megaprima Home Pte Ltd.
Designed in the USA
Made in Malaysia



We are available to assist you Monday -Friday from 9:00 am - 5:00 pm Eastern Standard Time.
1-800-729-1569
USA only.

BETTER HOMES & GARDENS ADJUSTABLE SHELF CUBE STORAGE

VENDOR STOCK NUMBERS
BH5336278612102-LIGHT HONEY
BH5336278612103-CHARCOAL

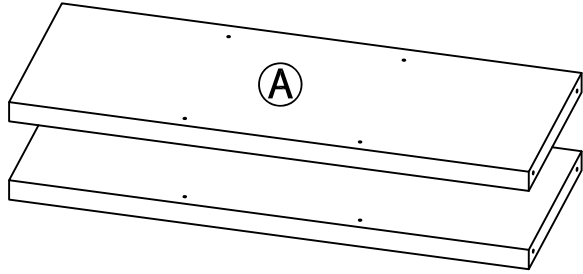

Top/Bottom panel
(Qty: 2)

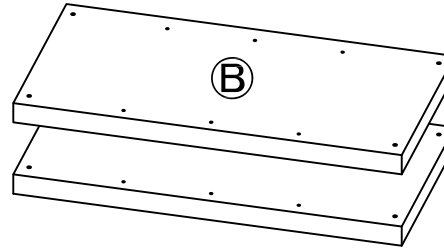

Side panel
(Qty: 2)

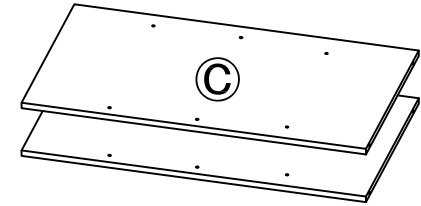

Partition board
(Qty: 2)

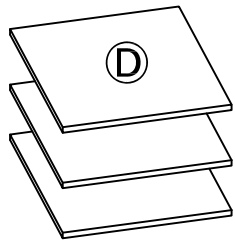

Adjustable shelf
(Qty: 3)

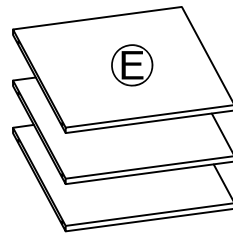

Fixed shelf
(Qty: 3)

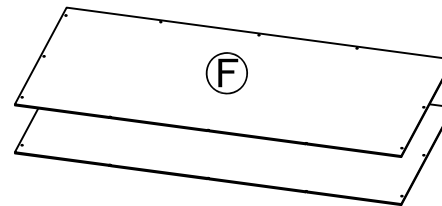

Back panel 1
(Qty: 2)

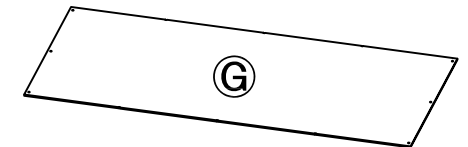

Back panel 2
(Qty: 1)

VERIFY THAT ALL PARTS ARE PRESENT BEFORE BEGINNING



We are available to assist you Monday -Friday
from 9:00 am - 5:00 pm Eastern Standard Time.
1-800-729-1569
USA only.

BETTER HOMES & GARDENS ADJUSTABLE SHELF CUBE STORAGE

VENDOR STOCK NUMBERS
 BH5336278612102-LIGHT HONEY
 BH5336278612103-CHARCOAL

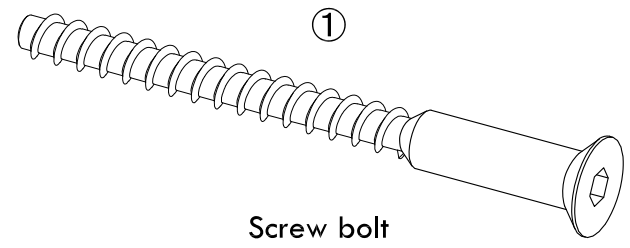
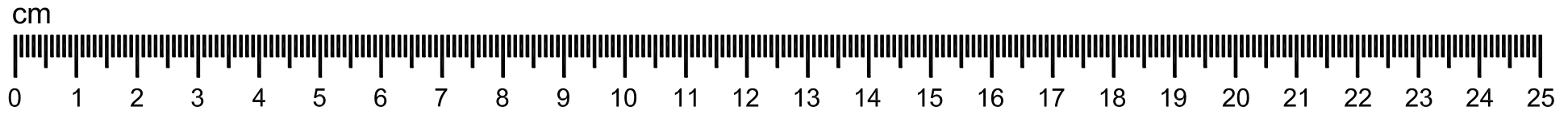

①
 Screw bolt
 Qty: 8

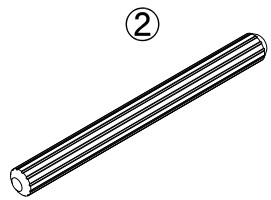

②
 Dowel
 Qty: 16

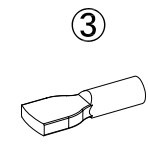

③
 Shelf support
 Qty: 12

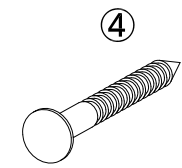

④
 Nail
 Qty: 24+1 Extra

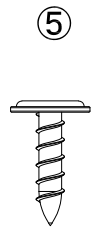
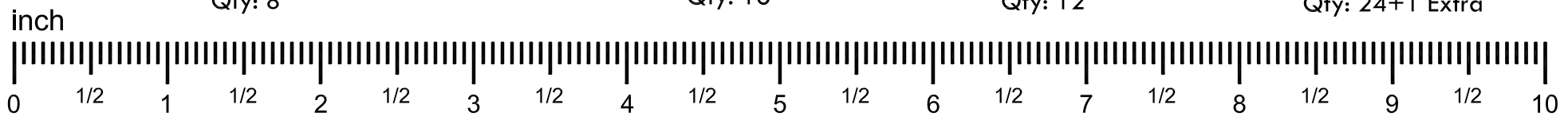

⑤
 Screw
 Qty: 6

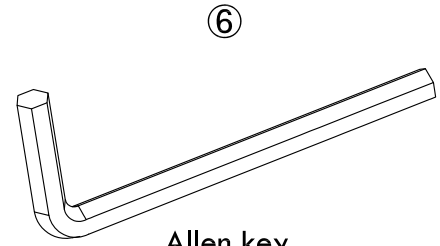

⑥
 Allen key
 Qty: 1

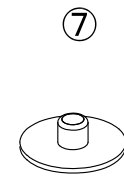

⑦
 Cap
 Qty: 8+1 Extra

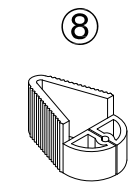

⑧
 Nail holder
 Qty: 1

VERIFY THAT ALL PARTS ARE PRESENT BEFORE BEGINNING



We are available to assist you Monday -Friday
 from 9:00 am - 5:00 pm Eastern Standard Time.
1-800-729-1569
 USA only.

1

Insert four dowels ② into ③ panels.
Insert four dowels ② into **two** of the ④ panels.

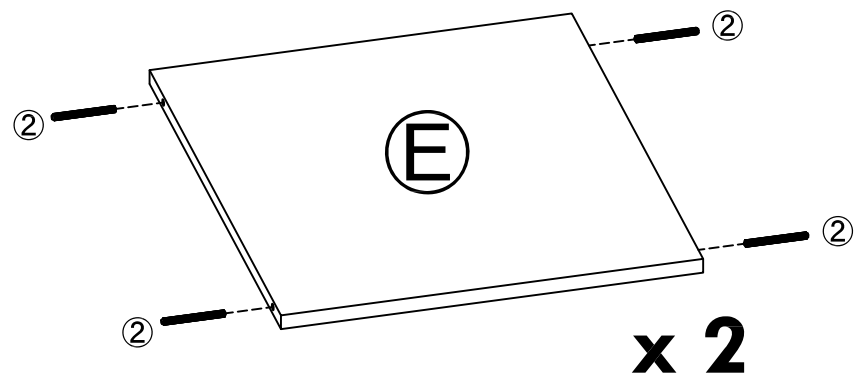
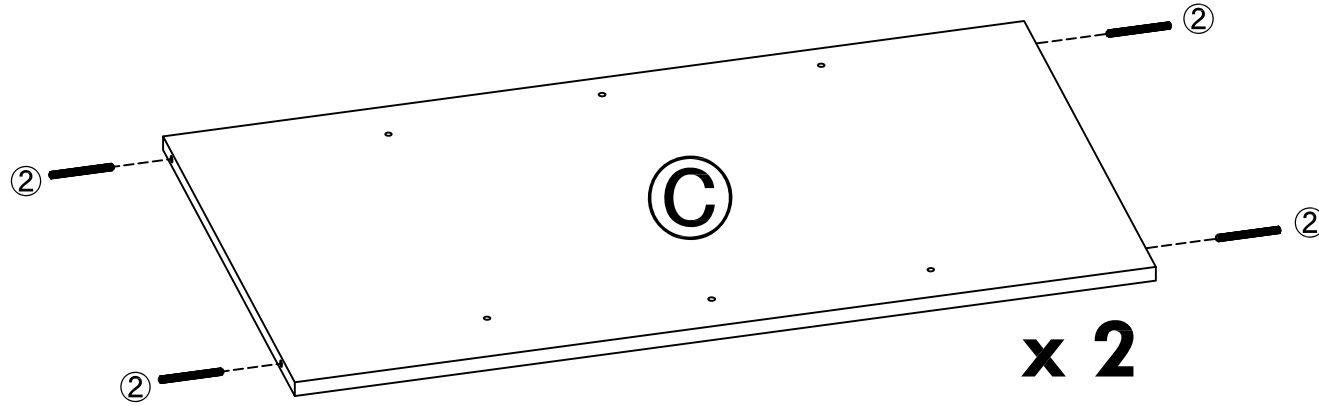

ADDITIONAL NOTES

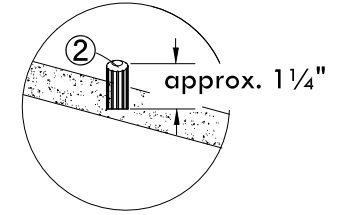

PARTS

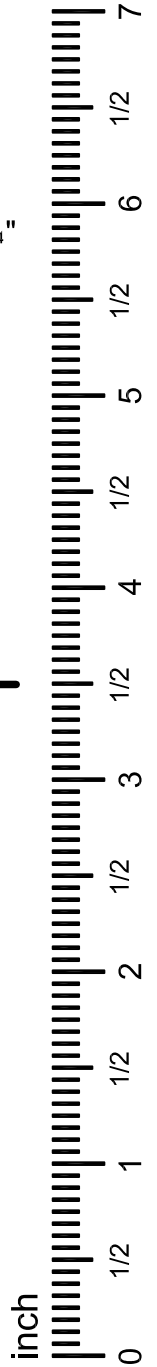
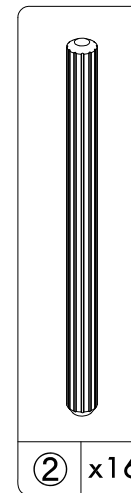

2

Align and attach **E** panels to **C** panels.

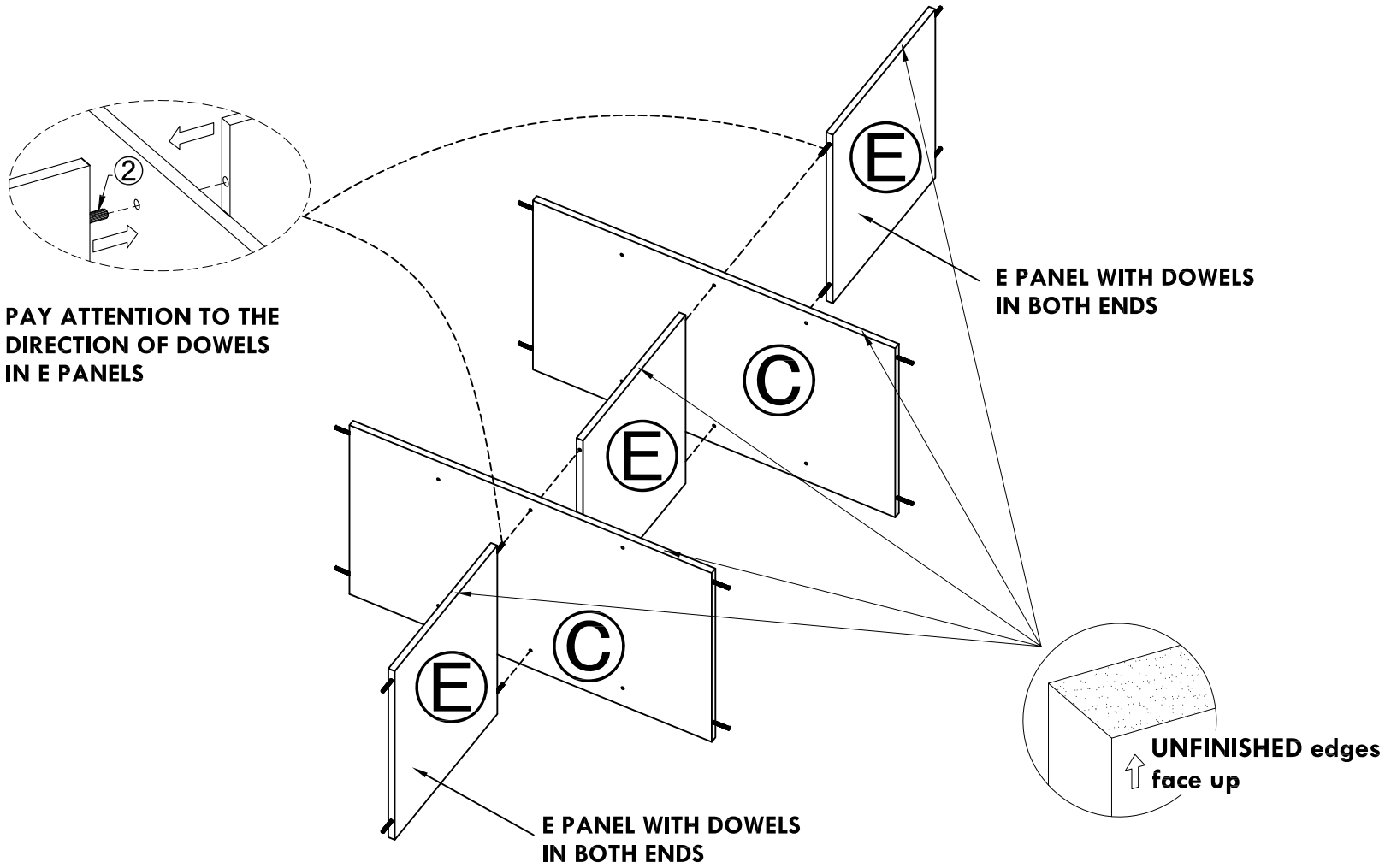

3

Connect **A** panels to structure.

⚠ WARNING

Do not move product until **B** (side panels) are attached.
Failure to follow this could result in product damage and failure.

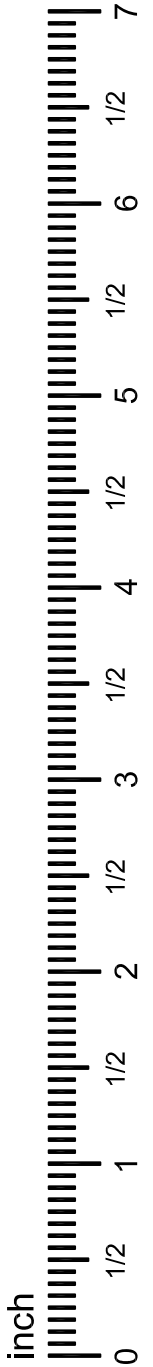
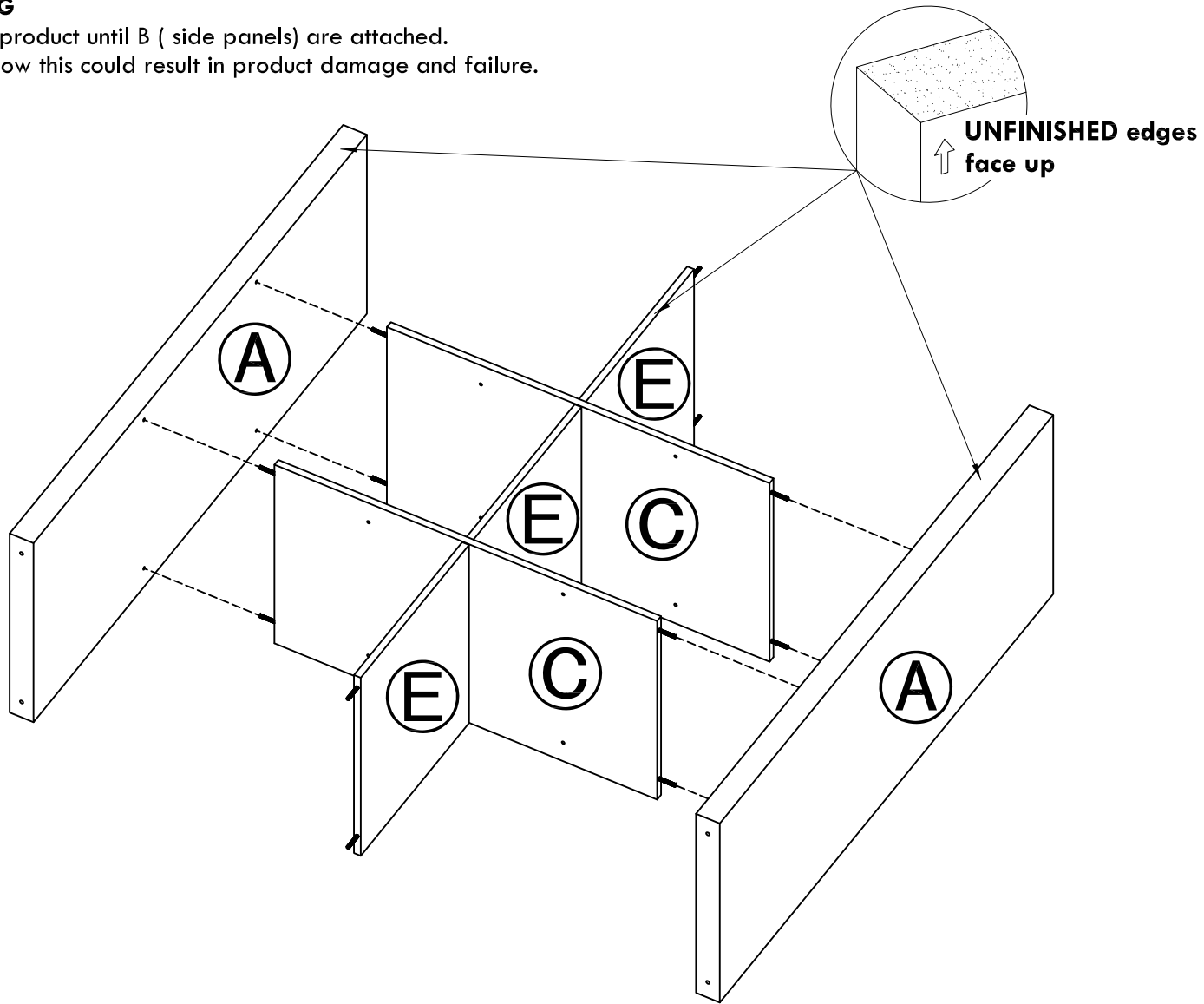

4

Use screw bolt ① to attach ② panels to structure.
Use caps ⑦ to cover exposed screw heads in ② panels.

⚠ WARNING

Do not move product until B (side panels) are attached.
Failure to follow this could result in product damage and failure.

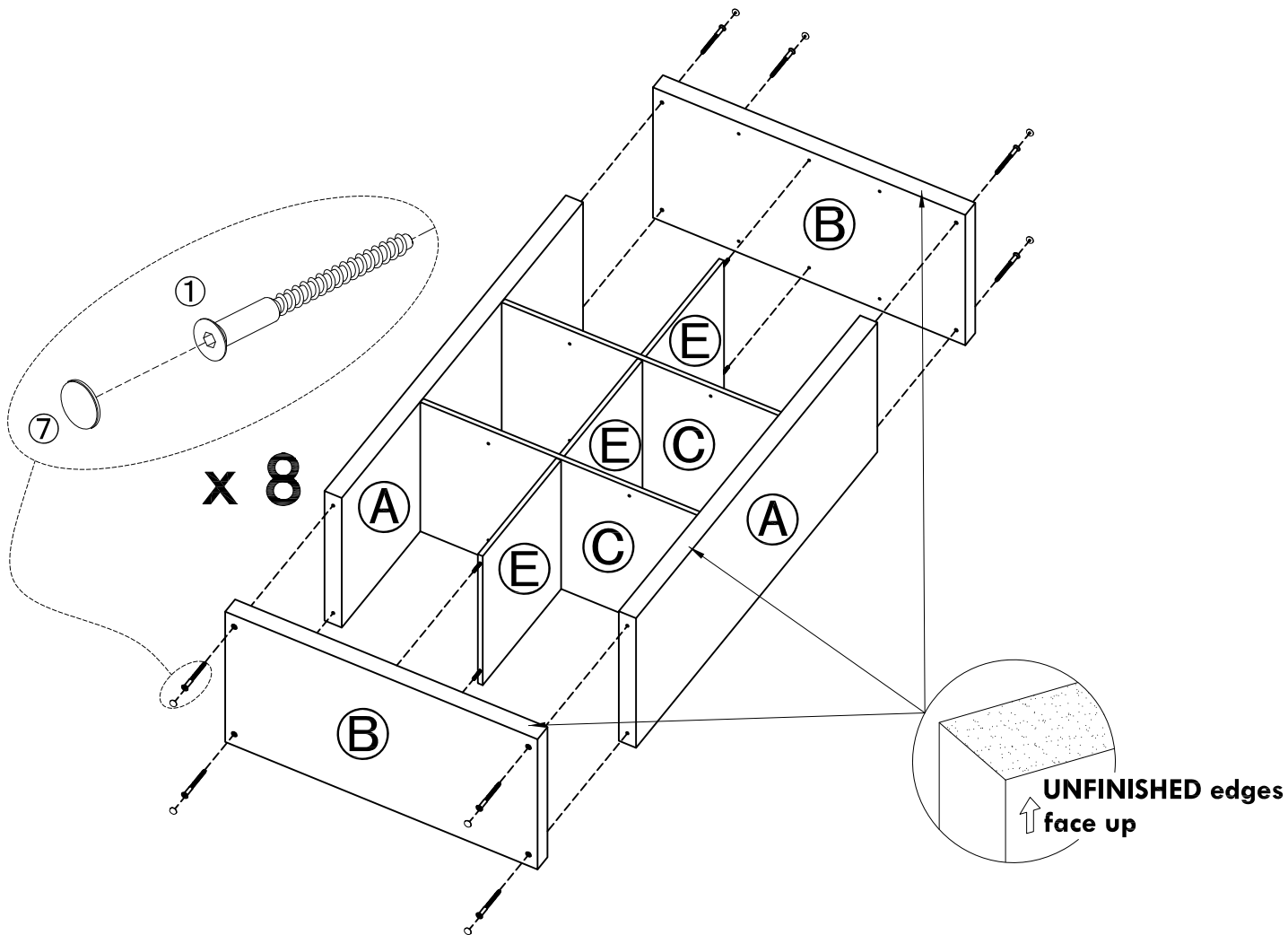

ADDITIONAL NOTES

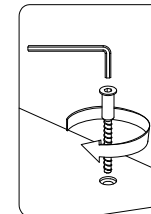

PARTS

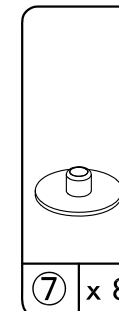
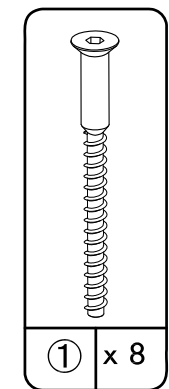

inch

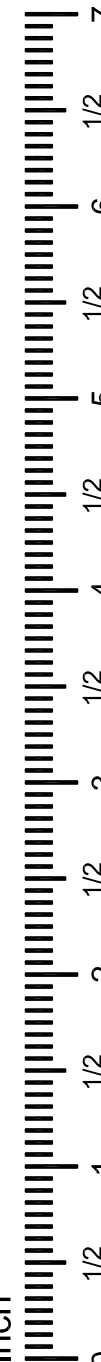

5

Align back panels **F** & **G** to the unit and use nails **4** & nail holder **8** to attach back panels along the **outside edges only**.

Place a nail into the nail holder and slide the nail holder up to the side of the unit until flush. The nail will be positioned in the center of the particle board. Hammer the nail slightly into board, then slide nail holder back and hammer the nail in the rest of the way.

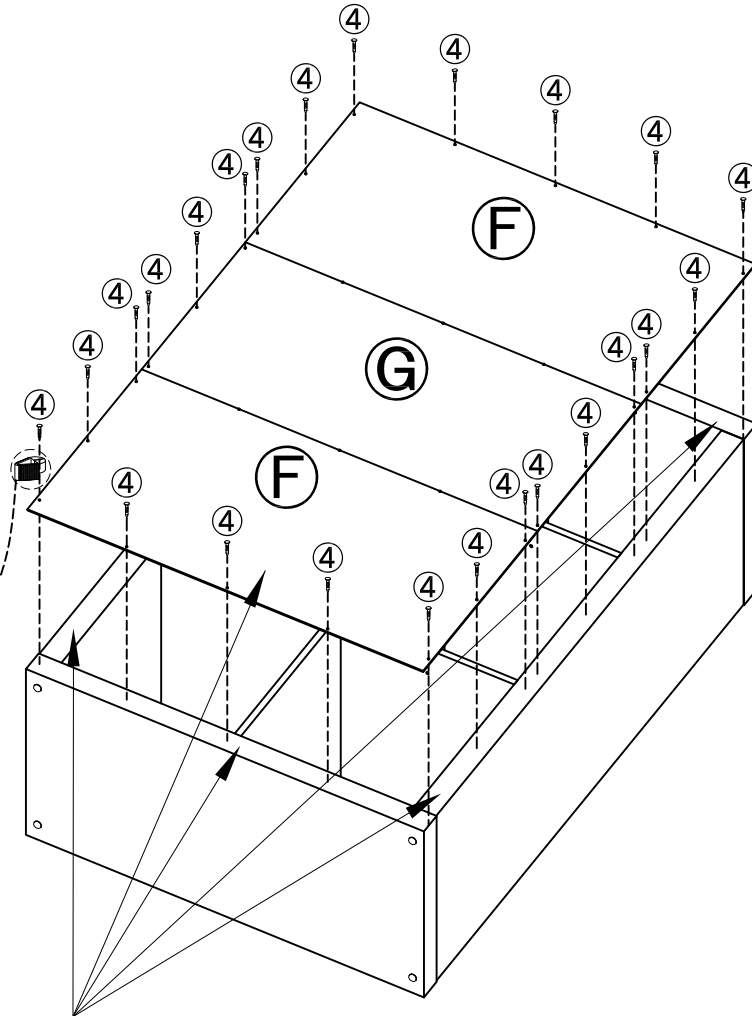
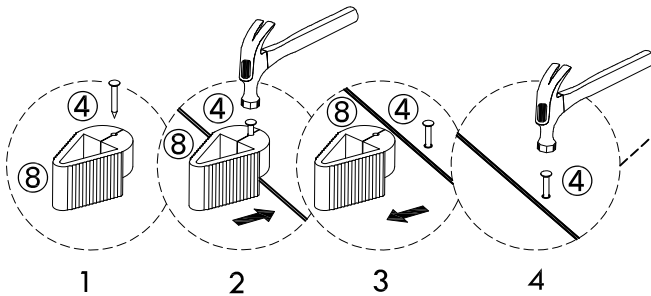

**UNFINISHED edges & sides
face up**

CAUTION: Back panels must be attached before moving or using unit. Failure to attach back panels will result in instability.

PARTS

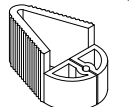
| | | | |
|---|------|---|-----|
|  | x 24 |  | x 1 |
|---|------|---|-----|

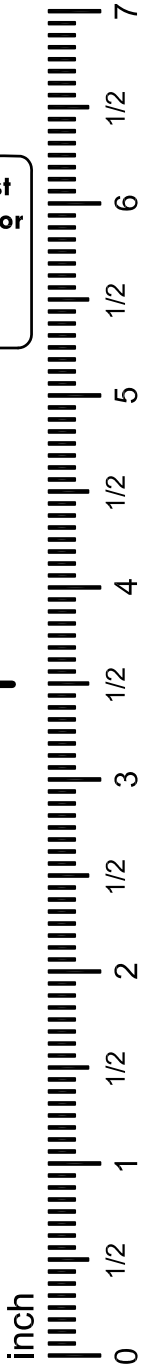

6

Use screws ⑤ to attach back panels **F** & **G** along **inside edges** as shown.

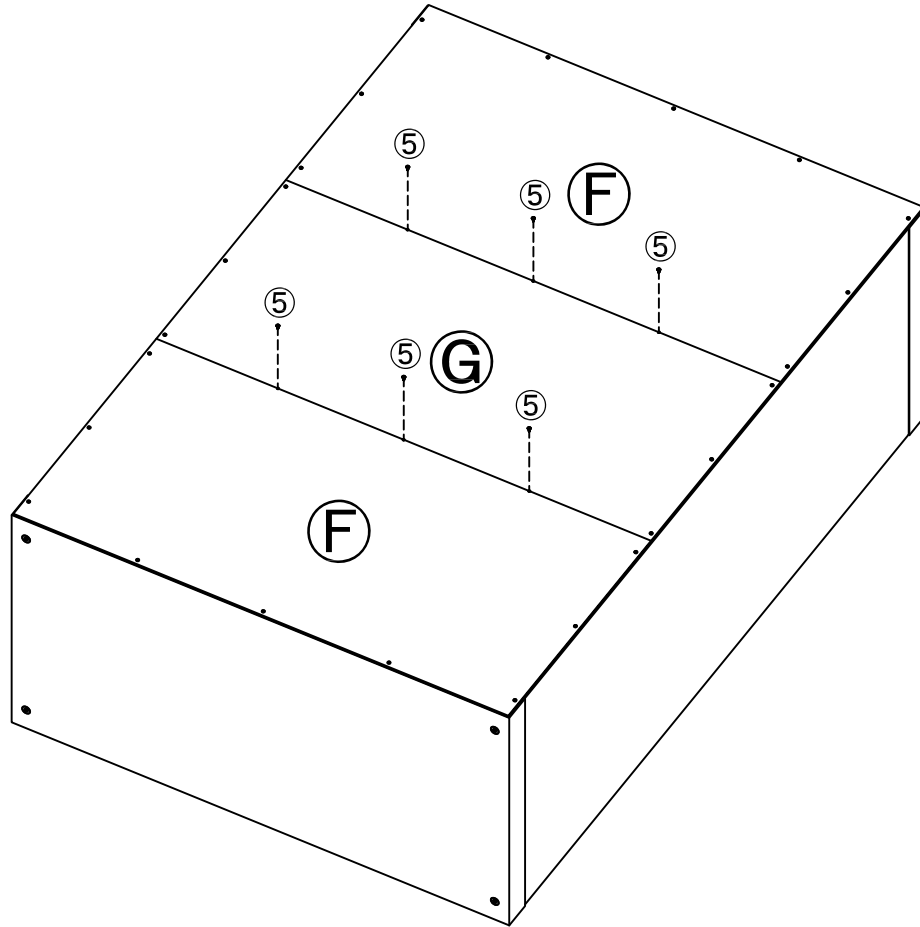

ADDITIONAL NOTES

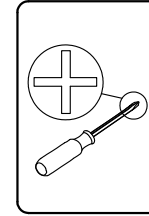

PARTS

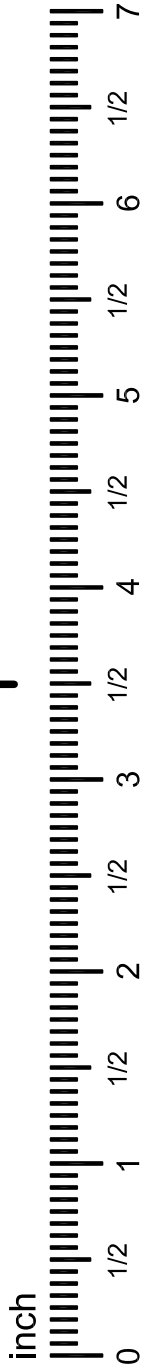
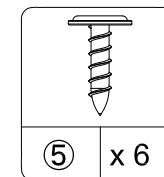

7

Insert shelf supports ③ into ② & ③ panels in desired locations and install adjustable shelves ④.

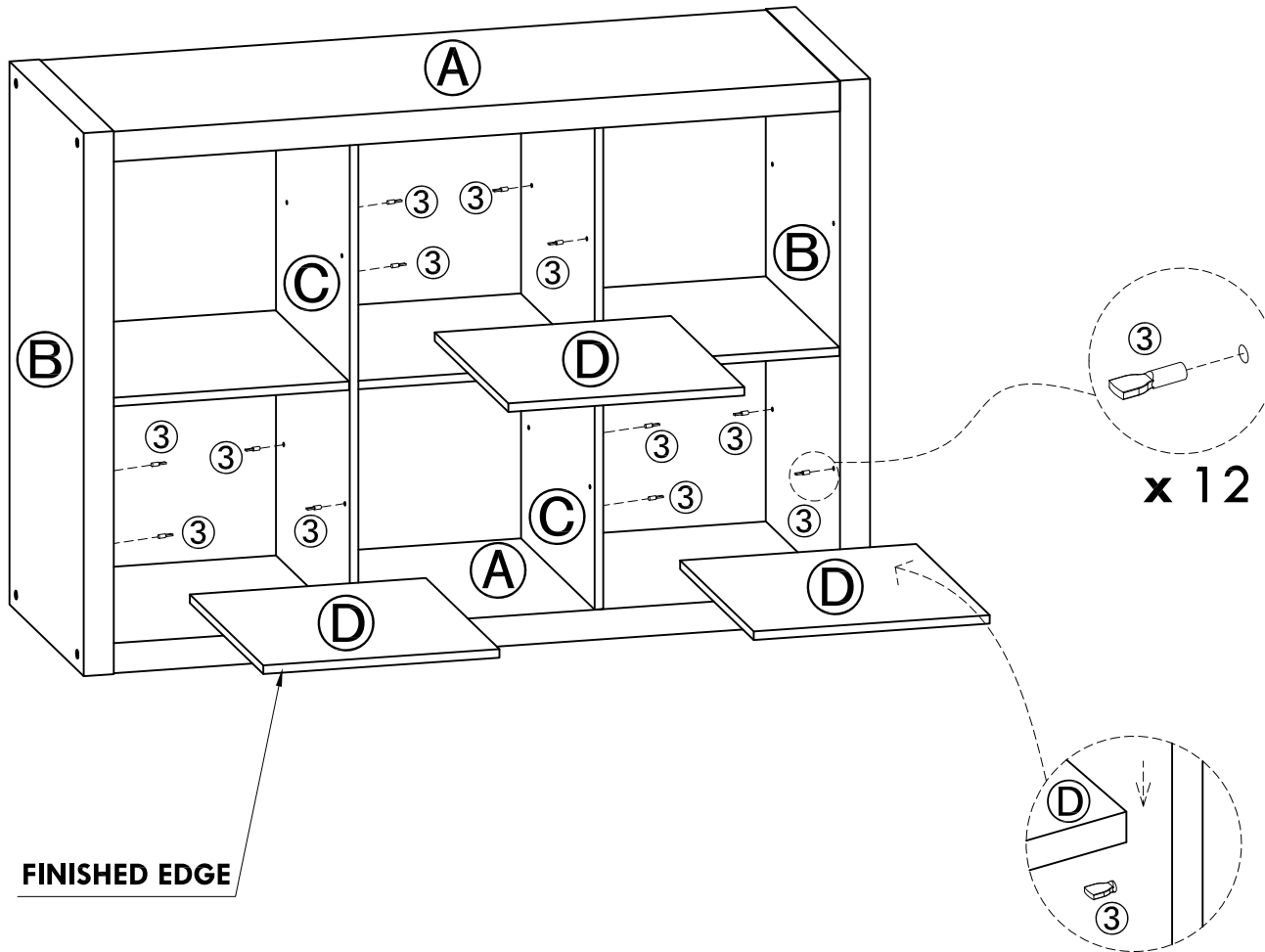

PARTS

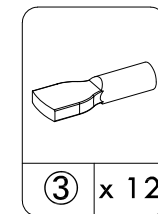

CONGRATULATIONS, YOUR UNIT IS COMPLETE, PLEASE ENJOY AND BE SURE TO TELL US ABOUT YOUR EXPERIENCE!

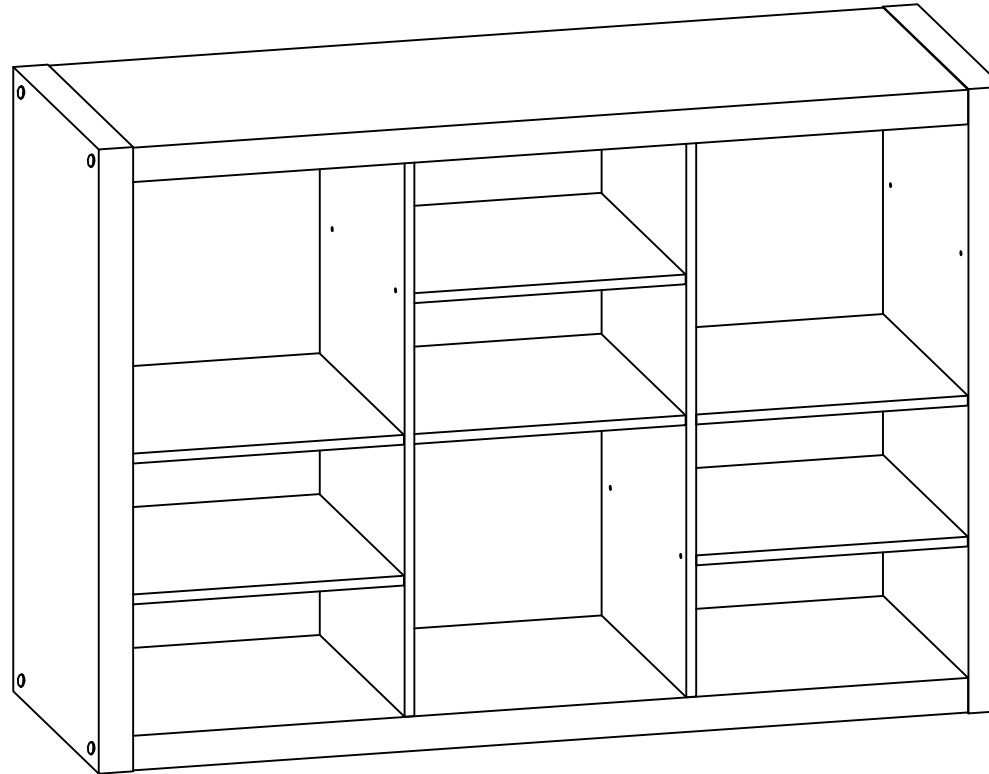

Quality Guarantee

Should this product be defective in workmanship or materials or fail under normal use, we will repair or replace it for up to (1) year from date of purchase.

This warranty gives you specific legal rights and you may also have other rights which vary from State to State.

**Please call for replacement parts or assistance: 1-800-729-1569
Monday - Friday 9:00 am - 5:00 pm EST**

BETTER HOMES & GARDENS

ALMACENAMIENTO DE CUBO AJUSTABLE

NÚMERO DE STOCK DEL VENDEDOR
BH5336278612102-MIEL CLARA
BH5336278612103-CARBÓN

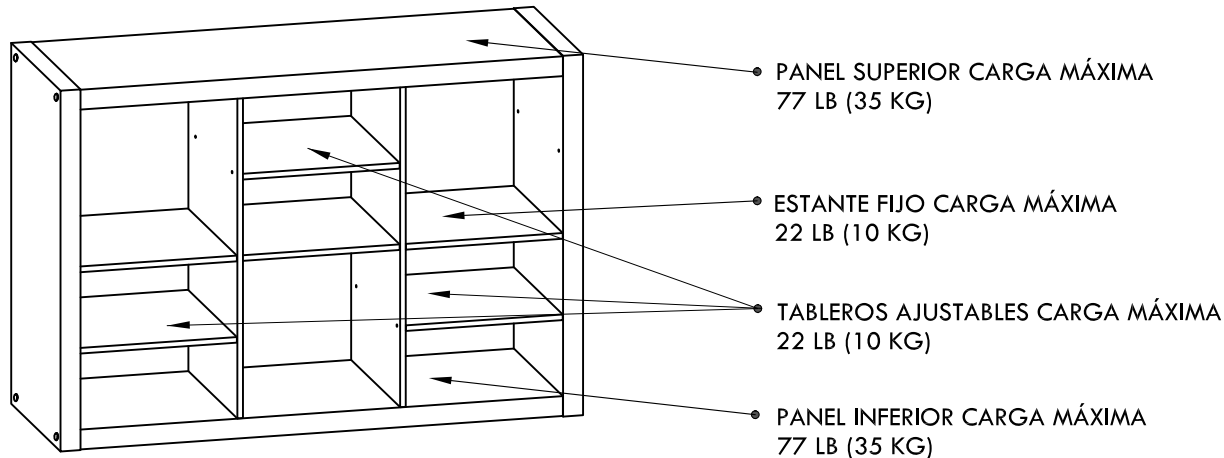

NÚMERO DE PERSONAS RECOMENDADO PARA EL ENSAMBLAJE: 1
TIEMPO ESTIMADO DE ENSAMBLAJE: 1 HORA

- LLAME A NUESTRO NÚMERO GRATUITO **1-800-729-1569** PARA OBTENER MÁS AYUDA.
- PIEZAS ADICIONALES ESTÁN DISPONIBLES POR UNA TARIFA.
- ESTE MANUAL DE INSTRUCCIÓN CONTIENE INFORMACIÓN **IMPORTANTE** DE SEGURIDAD. POR FAVOR DE LEER Y GUARDAR PARA FUTURAS REFERENCIAS.
- NO DEJAR A LOS NIÑOS SUBIR O JUGAR SOBRE LA UNIDAD.
- LIMPIAR EL PRODUCTO CON TU PULIDOR FAVORITE DE MUEBLE Y UN TRAPO BLANDO.
- NO USAR QUÍMICOS FUERTES O PRODUCTO DE LIMPIEZA ABRASIVO.
- MUEVA SUS NUEVOS MUEBLES CUIDADOSAMENTE CON DOS PERSONAS, NUNCA EMPUJE O ARRASTRE LA UNIDAD.

NO DEVOLVER EL PRODUCTO A LA TIENDA.
TIENDAS INDIVIDUALES NO RESERVAN PIEZAS.
PARA PIEZAS PERDIDAS O DAÑADAS LLAME AL
1-800-729-1569.
PARTES SERÁN ENVIADOS DE FORMA GRATUITA.
PARA UN SERVICIO RÁPIDO Y CONFIABLE, POR
FAVOR DE TENER A MANO EL MANUAL DE
ENSAMBLAJE.

NÚMERO DE PARTIDA _____
FECHA DE COMPRA ___/___/___

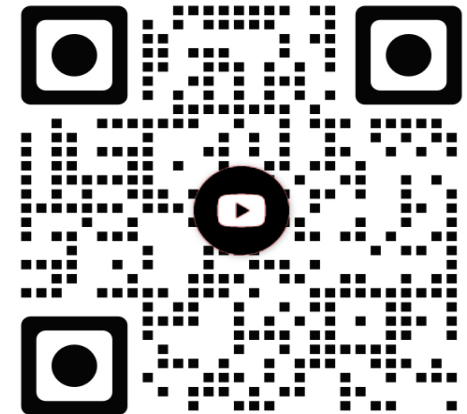

Abra su cámara y escanee el código
arriba para ver la guía de vídeo de
ensamblaje.

Megaprima Home Pte Ltd.
Diseñado en el E.E.U.U.
Hecho en Malaysia



Estamos disponibles para ayudarlo de Lunes - Viernes
de 9:00 am - 5:00 pm Hora de la Zona Este.
1-800-729-1569
Sólo E.E.U.U.

BETTER HOMES & GARDENS

ALMACENAMIENTO DE CUBO AJUSTABLE

NÚMERO DE STOCK DEL VENDEDOR
BH5336278612102-MIEL CLARA
BH5336278612103-CARBÓN



ANTES DE COMENZAR

- Leer y entender todos los pasos cuidadosamente antes de comenzar. si no se sigue cada paso en el orden correcto, el montaje será difícil y puede ocasionar daños.
- Trabajar en una zona amplia, mejor sobre la alfombra, cerca del sitio donde la unidad se utiliza.
- Asegurarse de que todas las piezas estén incluidos. La mayoría de los tableros están etiquetados con una pegatina removible.

Consejos útiles

- Llamar a nuestro número gratis para ayuda. Estamos disponibles para ayudarlo de lunes - Viernes de 9:00 am - 5:00 pm hora de la zona este.
- **1-800-729-1569** Sólo E.E.U.U.
O haga una solicitud a través de nuestro portal de autoservicio en www.huisenfurniture.zendesk.com

HERRAMIENTAS NECESARIAS PARA ENSAMBLAR

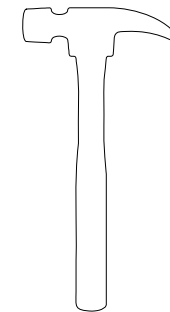
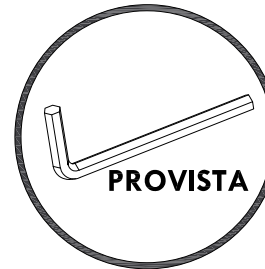

martillo



destornillador de
cabeza phillips



**NO UTILICE HERRAMIENTAS ELÉCTRICAS
PARA MONTAR SUS MUEBLES.
HERRAMIENTAS ELÉCTRICAS PUEDEN
PROVOCAR DAÑOS.**

Megaprima Home Pte Ltd.
Diseñado en el E.E.U.U.
Hecho en Malaysia



Estamos disponibles para ayudarlo de Lunes - Viernes
de 9:00 am - 5:00 pm Hora de la Zona Este.
1-800-729-1569
Sólo E.E.U.U.

BETTER HOMES & GARDENS

ALMACENAMIENTO DE CUBO AJUSTABLE

NÚMERO DE STOCK DEL VENDEDOR
BH5336278612102-MIEL CLARA
BH5336278612103-CARBÓN

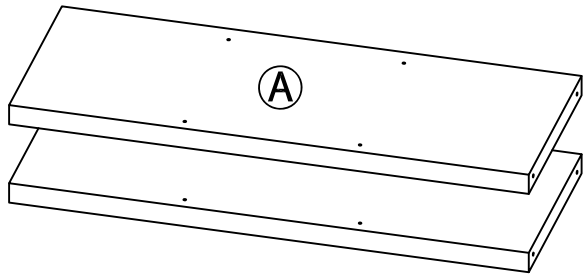

Panel superior/Inferior
(Cantidad: 2)

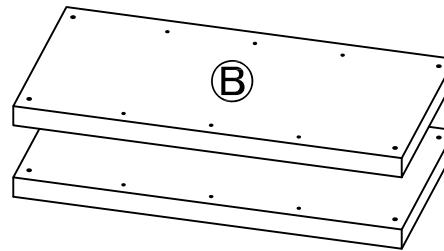

Panel lateral
(Cantidad: 2)



Tabla de tabique
(Cantidad: 2)



Tableros ajustables
(Cantidad: 3)

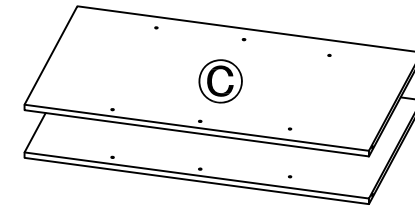
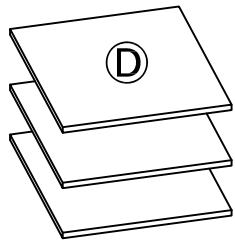
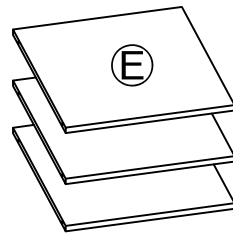

Estante fijo
(Cantidad: 3)

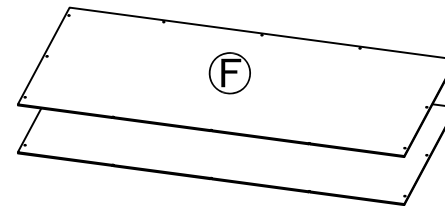

Panel posterior 1
(Cantidad: 2)

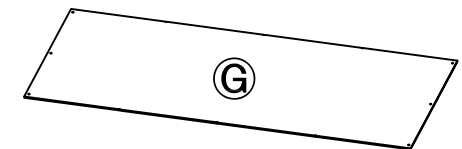

Panel posterior 2
(Cantidad: 1)

VERIFIQUE QUE TODAS LAS PIEZAS ESTÉN EN LA LISTA ANTES DE COMENZAR



Estamos disponibles para ayudarlo de Lunes - Viernes de 9:00 am - 5:00 pm Hora de la Zona Este.
1-800-729-1569
Sólo E.E.U.U.

BETTER HOMES & GARDENS

ALMACENAMIENTO DE CUBO AJUSTABLE

NÚMERO DE STOCK DEL VENDEDOR
 BH5336278612102-MIEL CLARA
 BH5336278612103-CARBÓN

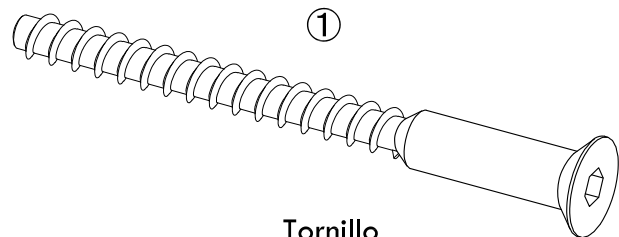

①
 Tornillo
 Cantidad: 8

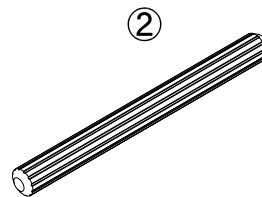

②
 Clavija
 Cantidad: 16

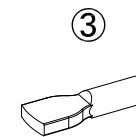

③
 Soporte de estante
 Cantidad: 12

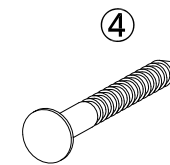

④
 Clavo
 Cantidad: 24+1 Extra

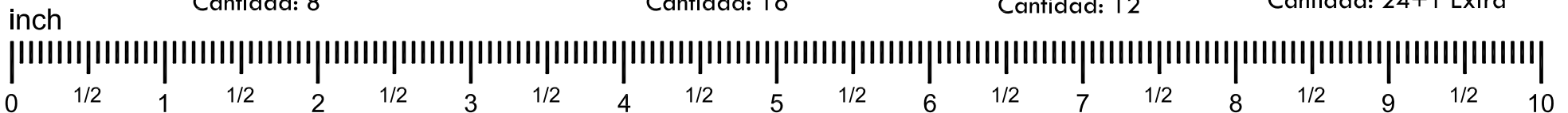

⑤
 Tornillo
 Cantidad: 6

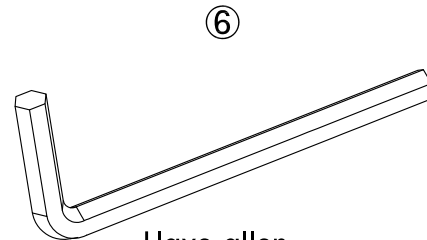

⑥
 Llave allen
 Cantidad: 1

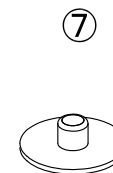

⑦
 Tapón
 Cantidad: 8+1 Extra

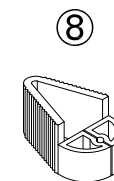

⑧
 Soporte de clavo
 Cantidad: 1

VERIFIQUE QUE TODAS LAS PIEZAS ESTÉN EN LA LISTA ANTES DE COMENZAR



Estamos disponibles para ayudarlo de Lunes - Viernes de 9:00 am - 5:00 pm Hora de la Zona Este.
1-800-729-1569
 Sólo E.E.U.U.

1

Insertar cuatro clavijas ② en paneles ③.
Insertar cuatro clavijas ② en **dos** paneles ④.

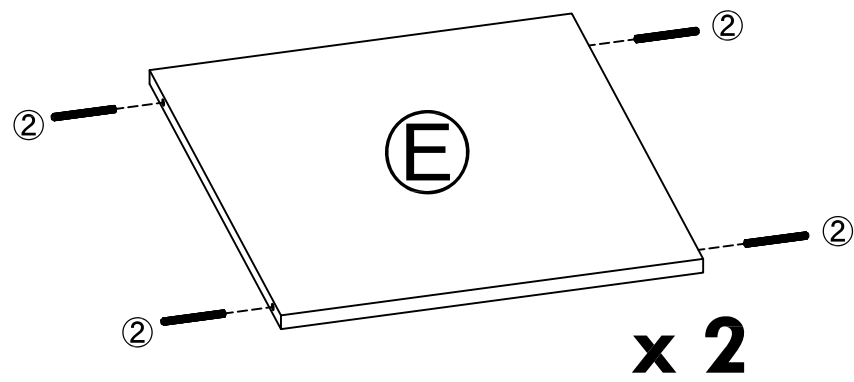
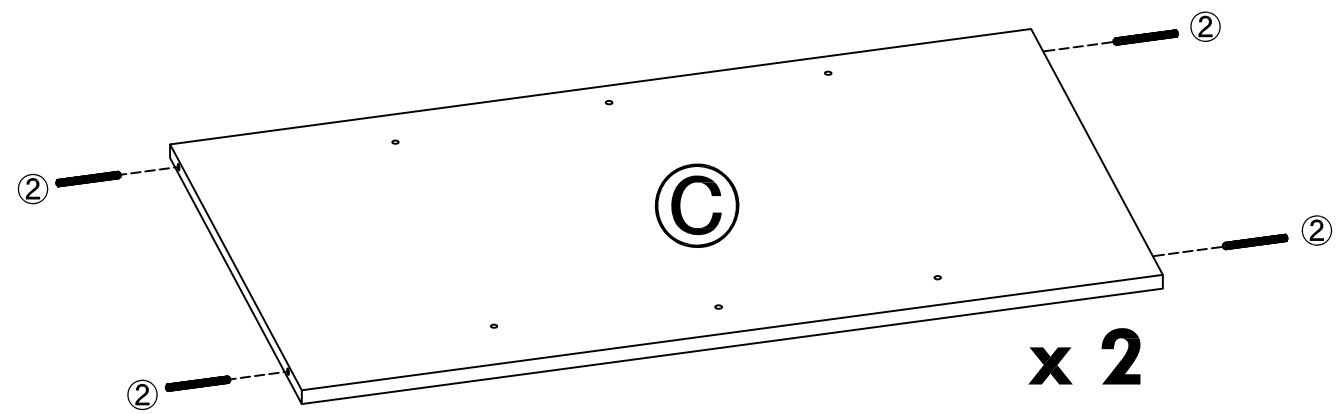

NOTAS ADICIONALES

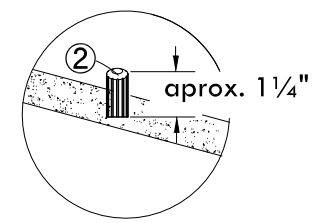

PARTES

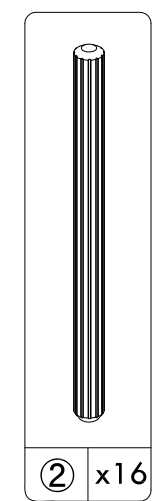

② x16

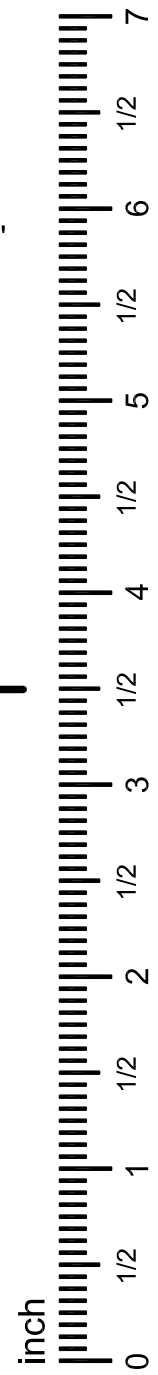

2

Alinee y fije la paneles **E** entre los paneles **C**.

POR FAVOR DE PRESTAR ATENCIÓN A LA DIRECCIÓN DE LAS CLAVIJAS EN PANELES E.

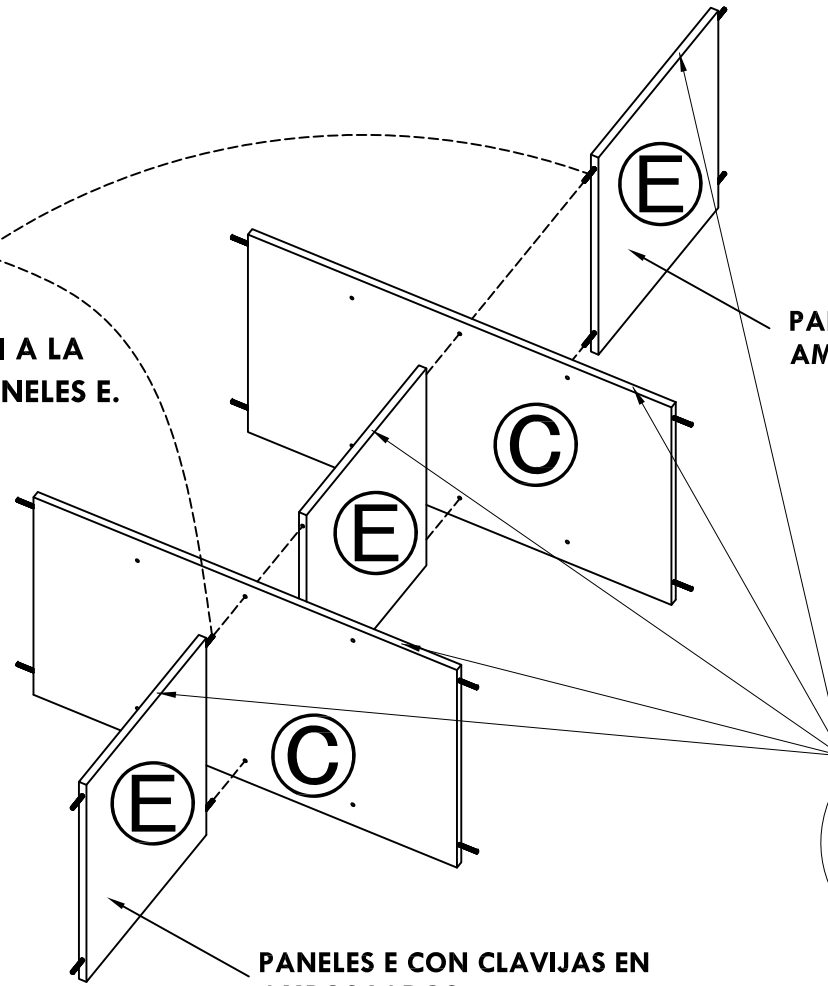
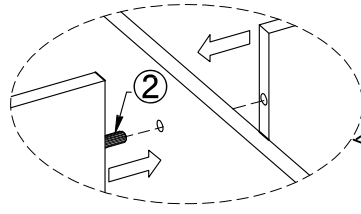

PANELES E CON CLAVIJAS EN AMBOS LADOS

PANELES E CON CLAVIJAS EN AMBOS LADOS

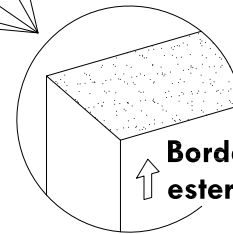

Bordes no acabados deben estar mirando hacia arriba



3

Conectar la (A) panel a estructura.

⚠ ADVERTENCIA

Este producto no se moverá hasta que los paneles B (panel lateral) panel estén unidos.
El incumplimiento de esto puede ocasionar daños y fallas en el producto.

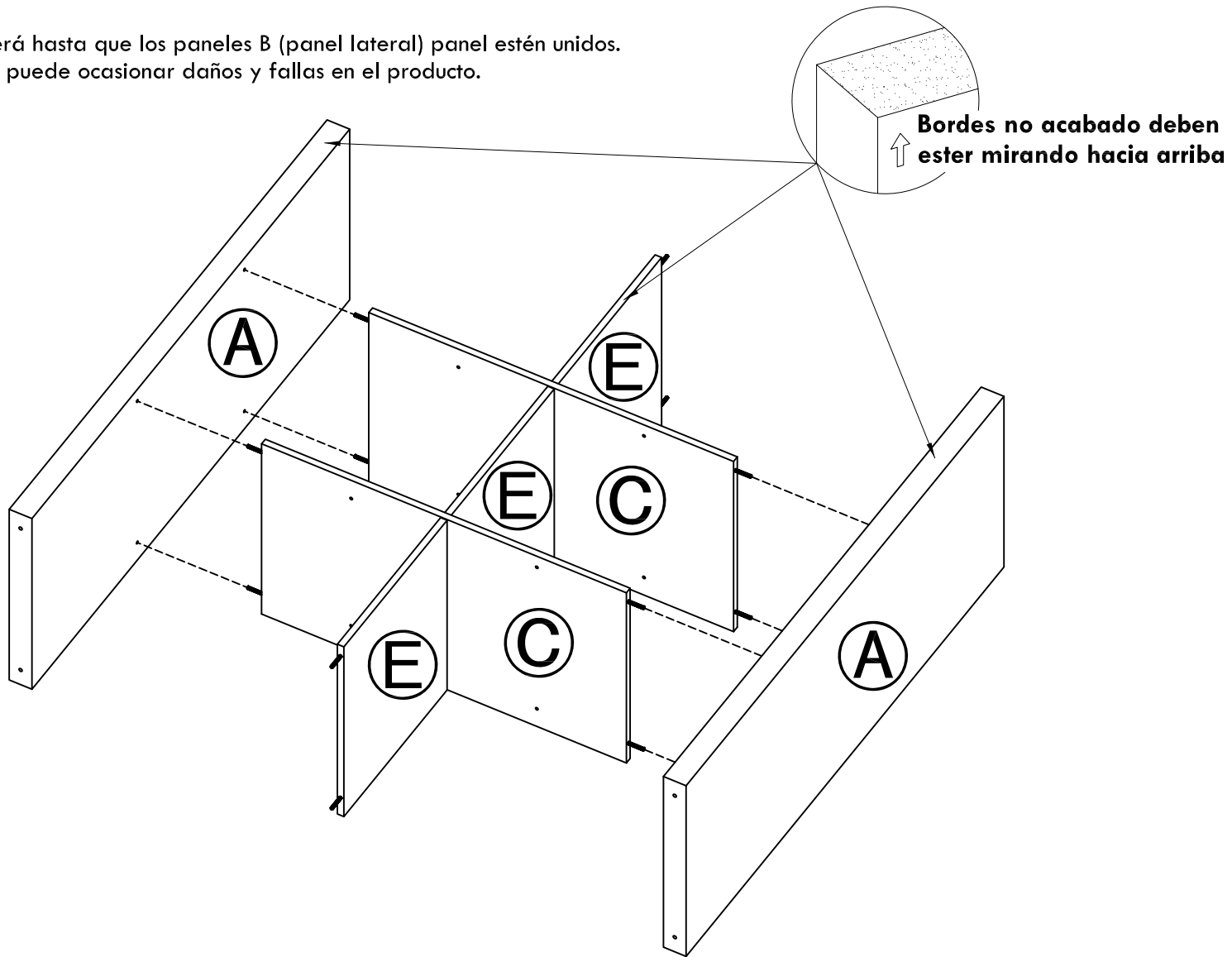

- 4** Utilice el tornillo ① para fijar el ② paneles a estructura.
 Utilice la tapón ⑦ para cubrir los cabezas el tornillo expuestos en el ② paneles.

⚠ ADVERTENCIA

Este producto no se moverá hasta que los paneles B (panel lateral) panel estén unidos.
 El incumplimiento de esto puede ocasionar daños y fallas en el producto.

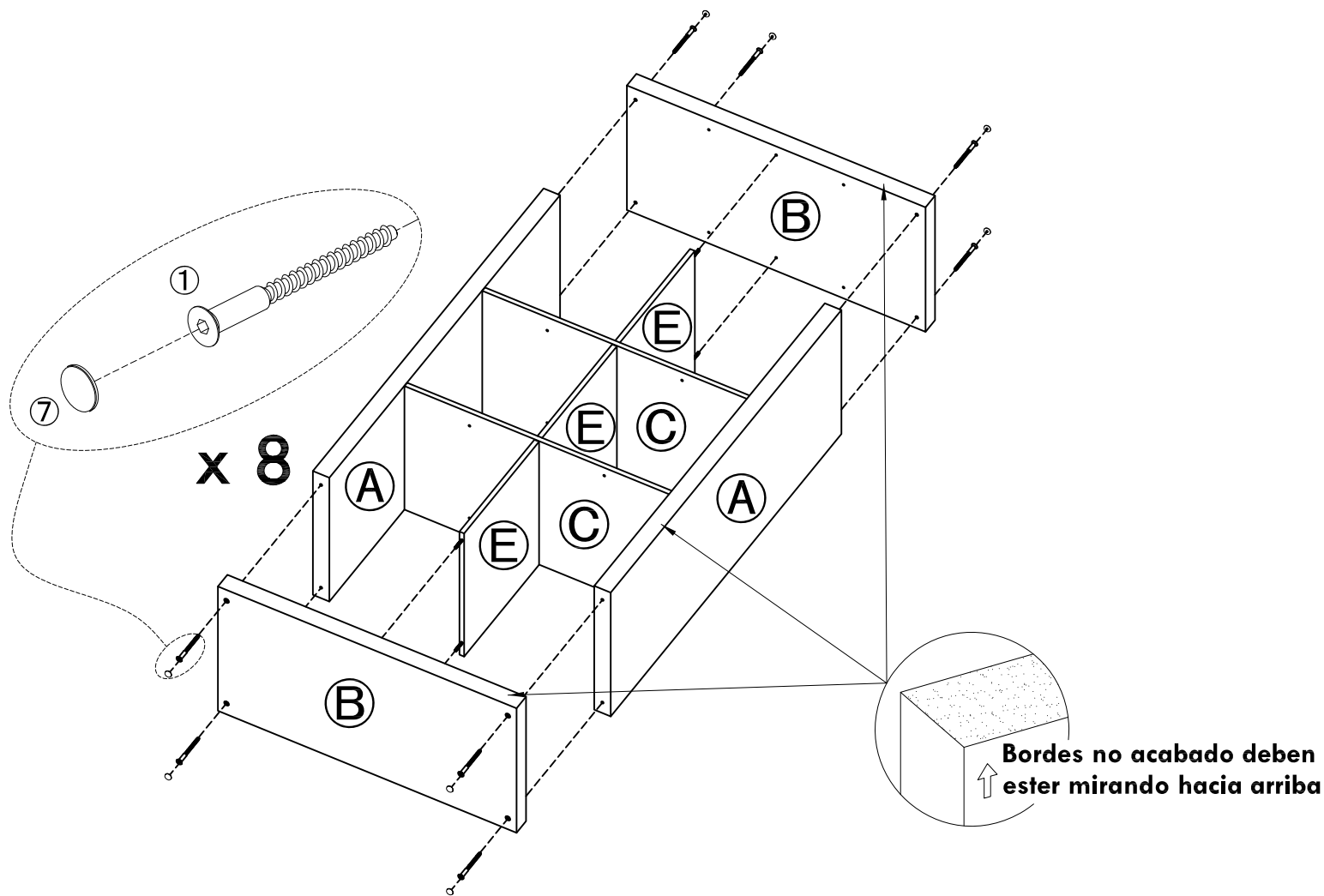

NOTAS ADICIONALES

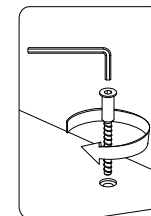

PARTES

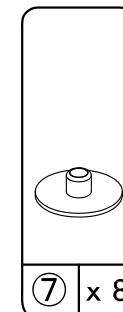
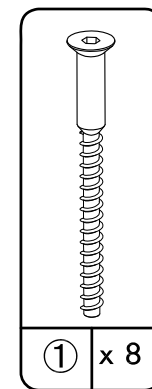

inch

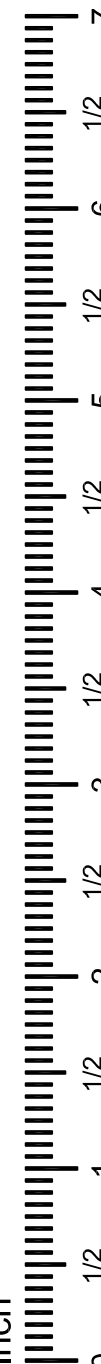

5

Alinee los paneles posterior (F) y (G) al conjunto, y sólo fije los paneles posterior a lo largo de **bordes exteriores** con clavos (4) y soporte de clavo (8).

PRECAUCIÓN: Los paneles traseros deben fijarse antes de mover o utilizar la unidad. El fallo de fijarse los paneles traseros resultará en inestabilidad.

Coloque un clavo en el soporte de clavos y deslice el soporte hacia el borde de la unidad hasta que quede al ras. El clavo se colocará en el centro del tablero de partículas. Martille el clavo ligeramente en el tablero, luego deslice el soporte hacia atrás y martille el resto de clavo.

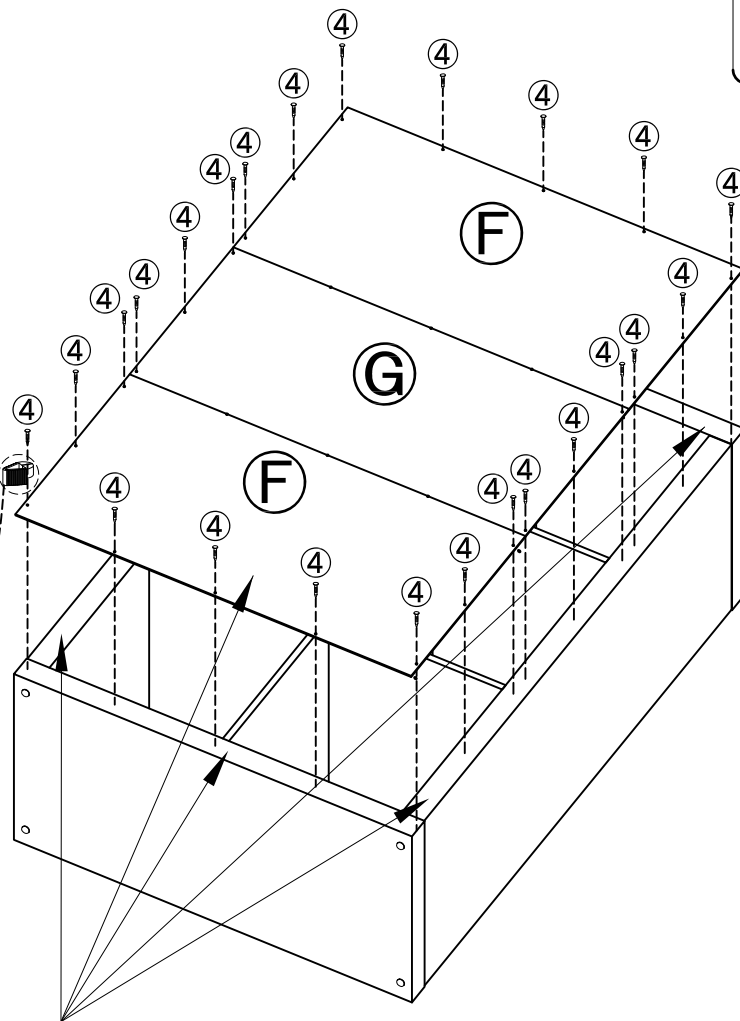
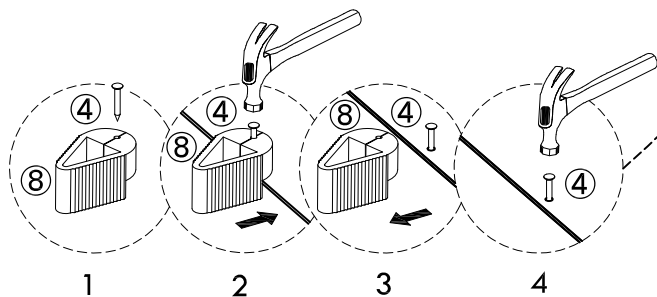

Bordes & lado no acabado deben estar mirando hacia arriba

PARTES

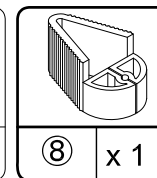
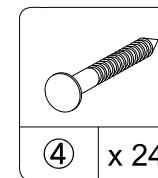

inch

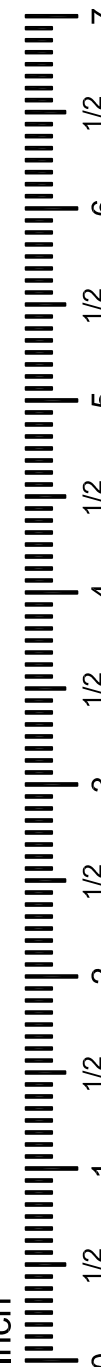

6

Fije los paneles posterior (F) & (G) a lo largo de **bordes interiores** con tornillos (5) como se muestra.

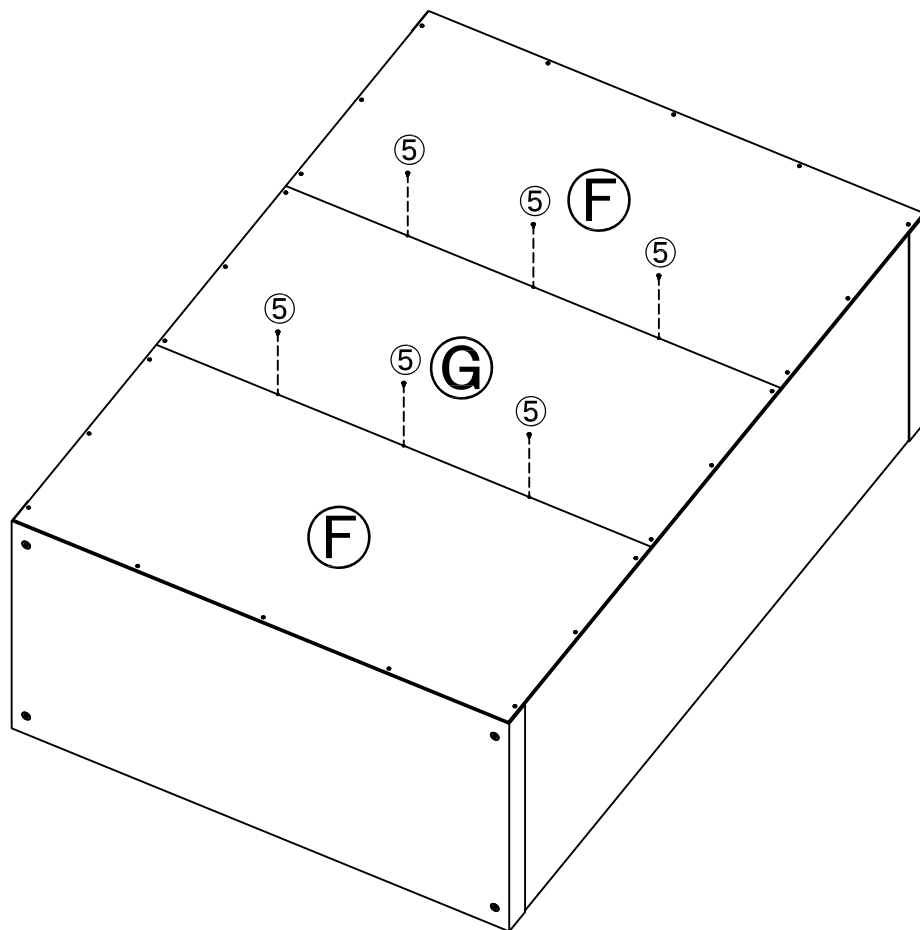

NOTAS ADICIONALES

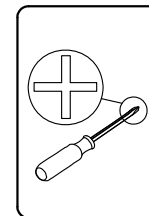

PARTES

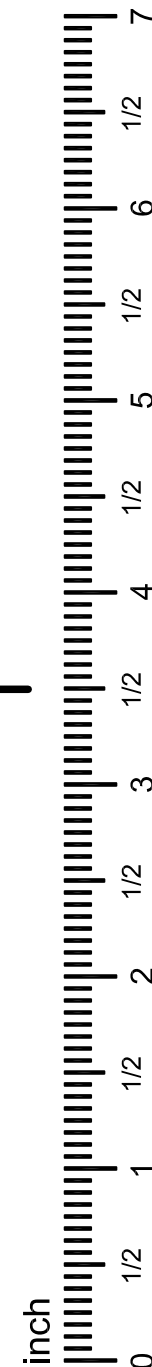
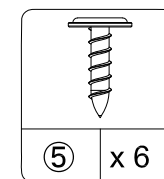

7

Inserte la soporta de estante ③ en la paneles ② y ③ en la posición requerida y instalar tableros ajustables ④.

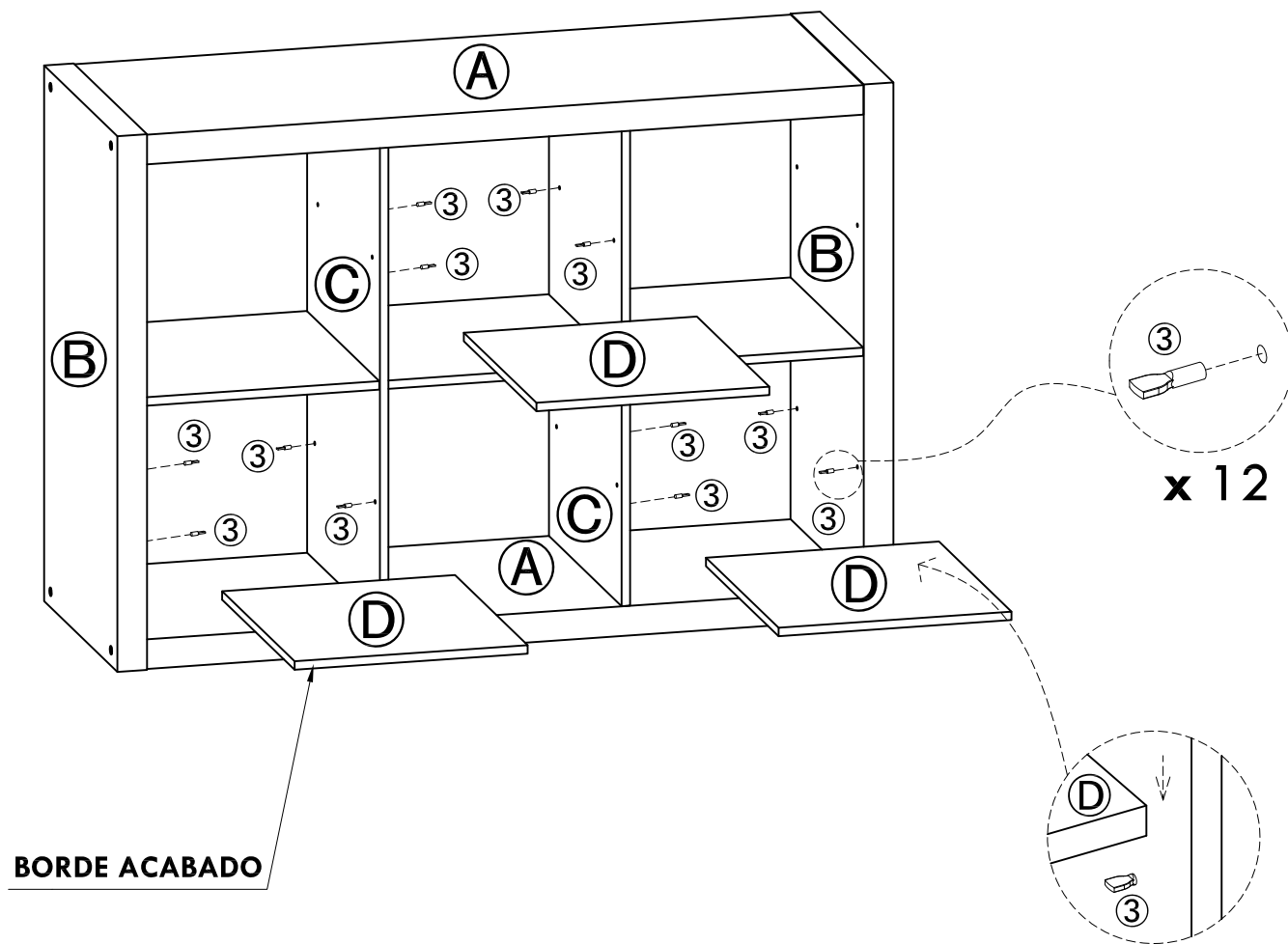

PARTES

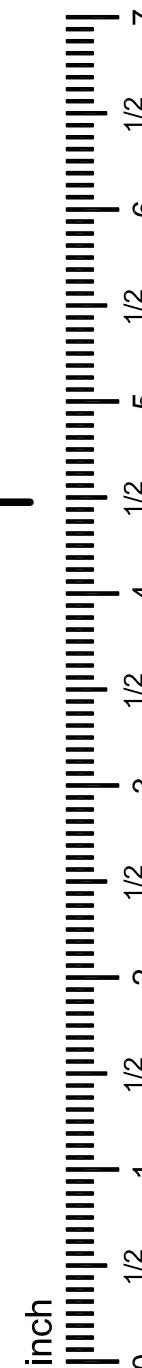
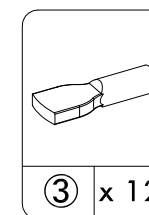

ENHORABUENA, SU ACCESORIO ESTÁ COMPLETO, ¡DISFRUTE Y NO DEJE DE CONTARNOS SU EXPERIENCIA!

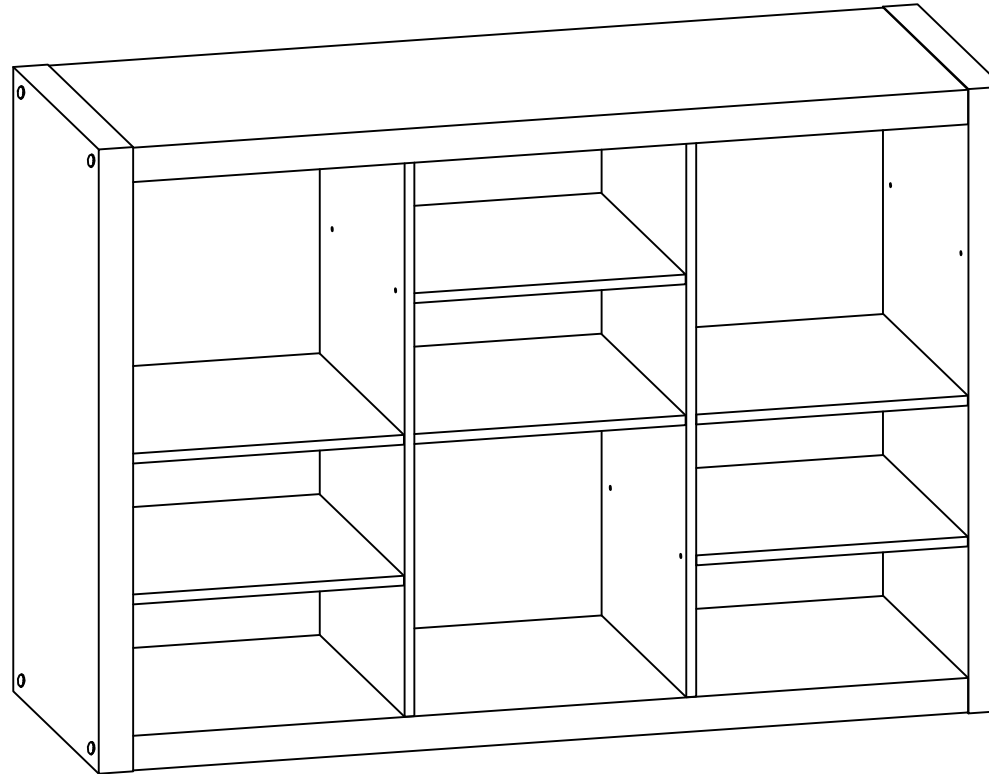

Garantía de Calidad

Si este producto presenta defectos de fabricación o de materiales o se cae bajo usos normales, lo arreglaremos o sustituiremos por hasta (1) año desde la fecha de compra.

Esta garantía te otorga derechos legales específicos y tú también tienes otros derechos que varían de un Estado a otro.

**Por favor de llamarnos para piezas de reemplazo o ayudas: 1-800-729-1569
Lunes - Viernes 9:00 am - 5:00 pm EST**