

BETTER HOMES & GARDENS OPEN SHELF CUBE STORAGE

VENDOR STOCK NUMBERS
BH5336278612099-WHITE TEXTURE
BH5336278612100-TOBACCO OAK
BH5336278612101- LIGHT HONEY

THIS PRODUCT MUST ALWAYS BE MOUNTED TO A WALL OR STUD FOR USE.

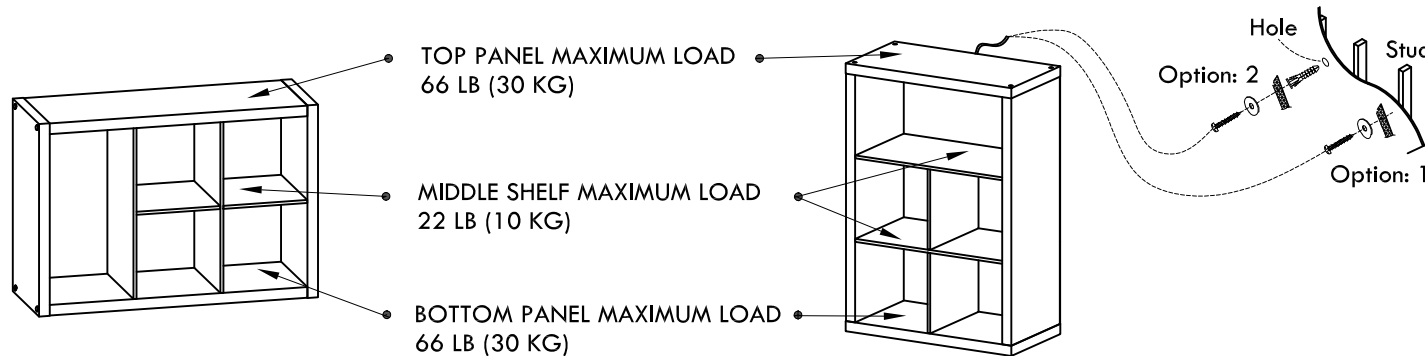

OPTIONAL CONFIGURATION

RECOMMENDED NUMBER OF PEOPLE FOR ASSEMBLY: 1
ESTIMATED ASSEMBLY TIME: 1 HOUR

- CALL OUR TOLL FREE NUMBER **1-800-729-1569** FOR FURTHER ASSISTANCE.
- ADDITIONAL PARTS ARE AVAILABLE FOR A FEE.
- THIS INSTRUCTION BOOKLET CONTAINS **IMPORTANT** SAFETY INFORMATION. PLEASE READ AND KEEP FOR FUTURE REFERENCE.
- DO NOT ALLOW CHILDREN TO CLIMB OR PLAY ON THE UNIT.
- CLEAN THE PRODUCT WITH YOUR FAVORITE FURNITURE POLISH AND A SOFT CLOTH.
- DO NOT USE HARSH CHEMICALS OR ABRASIVE CLEANERS.
- MOVE YOUR NEW FURNITURE CAREFULLY WITH TWO PEOPLE. NEVER PUSH OR DRAG THE UNIT.

DO NOT RETURN THE PRODUCT TO THE STORE.
INDIVIDUAL STORES DO NOT STOCK PARTS.
FOR MISSING OR DAMAGED PARTS CALL
1-800-729-1569.
PARTS WILL BE SHIPPED FREE OF CHARGE.

FOR PROMPT, RELIABLE SERVICE, PLEASE HAVE
YOUR ASSEMBLY MANUAL READY.

LOT NUMBER _____
DATE OF PURCHASE ___/___/___

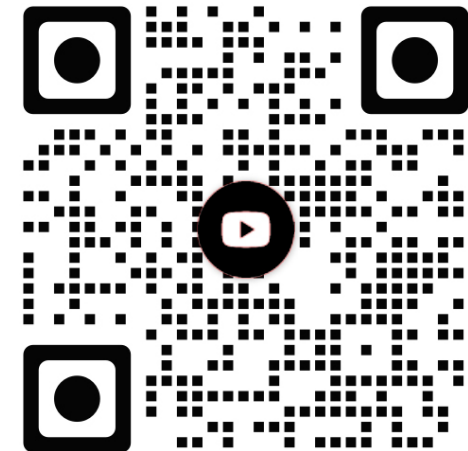

Open your camera and scan the QR code
above for a video assembly guide

Megaprima Home Pte Ltd.
Designed in the USA
Made in Malaysia



We are available to assist you Monday -Friday
from 9:00 am - 5:00 pm Eastern Standard Time.
1-800-729-1569
USA only.

BETTER HOMES & GARDENS OPEN SHELF CUBE STORAGE

VENDOR STOCK NUMBERS
BH5336278612099-WHITE TEXTURE
BH5336278612100-TOBACCO OAK
BH5336278612101- LIGHT HONEY



BEFORE STARTING

- Read and understand all the steps carefully before starting. If each step is not followed in the correct order the assembly will be difficult and may result in damages.
- Work in a spacious area, preferably on a carpeted surface, near where the unit will be used.
- Make sure all the parts are included. Most boards are labeled with a removable sticker.

Helpful hints

- Call our toll free number if you need assistance. We are available to assist you Monday - Friday from 9:00 am - 5:00 pm Eastern Standard Time.
- **1-800-729-1569** USA only. Or submit a request through our self-service portal at www.huisenfurniture.zendesk.com

TOOLS NEEDED TO ASSEMBLE

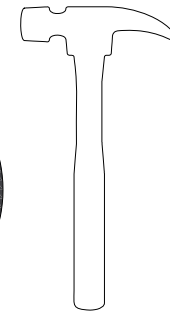
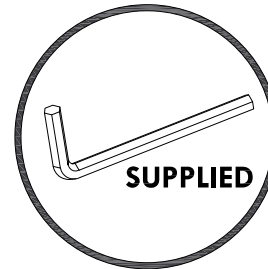

hammer



phillips head
screwdriver



DO NOT USE POWER TOOLS TO ASSEMBLE YOUR FURNITURE. POWER TOOLS MAY RESULT IN DAMAGE.

Megaprima Home Pte Ltd.
Designed in the USA
Made in Malaysia



We are available to assist you Monday -Friday from 9:00 am - 5:00 pm Eastern Standard Time.
1-800-729-1569
USA only.

BETTER HOMES & GARDENS OPEN SHELF CUBE STORAGE

VENDOR STOCK NUMBERS
BH5336278612099-WHITE TEXTURE
BH5336278612100-TOBACCO OAK
BH5336278612101- LIGHT HONEY

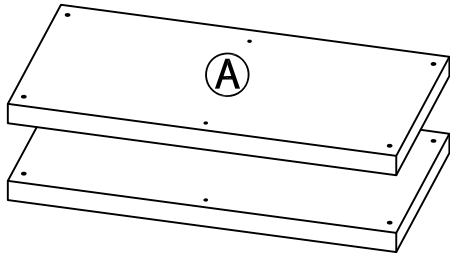

Top/Bottom panel
(Qty: 2)

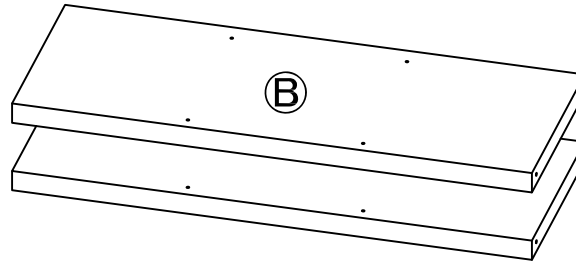

Side panel
(Qty: 2)

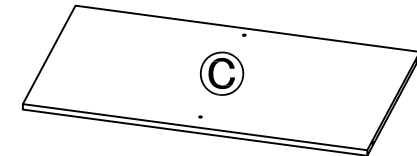

Middle shelf 1
(Qty: 1)

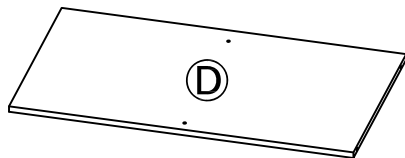

Middle shelf 2
(Qty: 1)

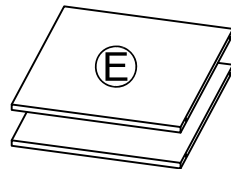

Partition board
(Qty: 2)

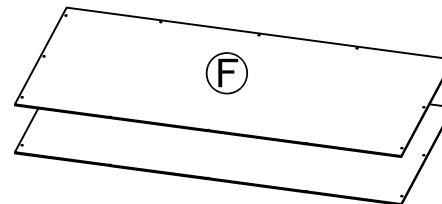

Back panel 1
(Qty: 2)

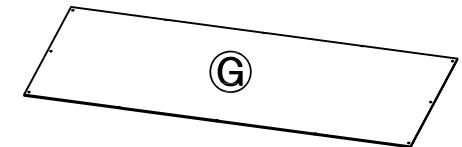

Back panel 2
(Qty: 1)

VERIFY THAT ALL PARTS ARE PRESENT BEFORE BEGINNING



We are available to assist you Monday -Friday
from 9:00 am - 5:00 pm Eastern Standard Time.
1-800-729-1569
USA only.

BETTER HOMES & GARDENS OPEN SHELF CUBE STORAGE

VENDOR STOCK NUMBERS
 BH5336278612099-WHITE TEXTURE
 BH5336278612100-TOBACCO OAK
 BH5336278612101- LIGHT HONEY

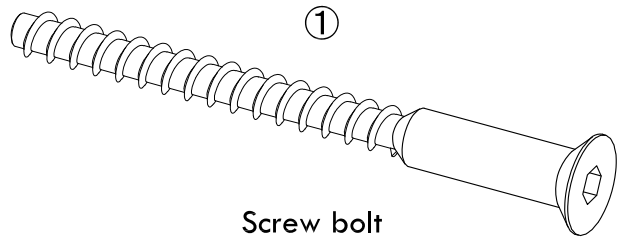

①
Screw bolt
Qty: 8

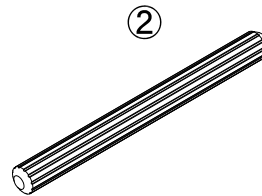

②
Long dowel
Qty: 12

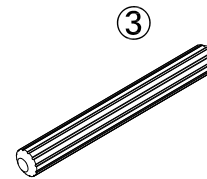

③
Short dowel
Qty: 2

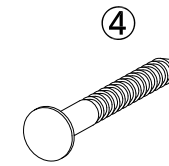

④
Nail
Qty: 24+1 Extra

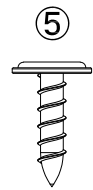

⑤
Screw
Qty: 6

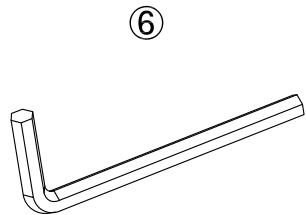

⑥
Allen key
Qty: 1

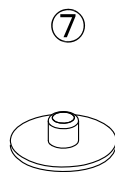

⑦
Cap
Qty: 8+1 Extra

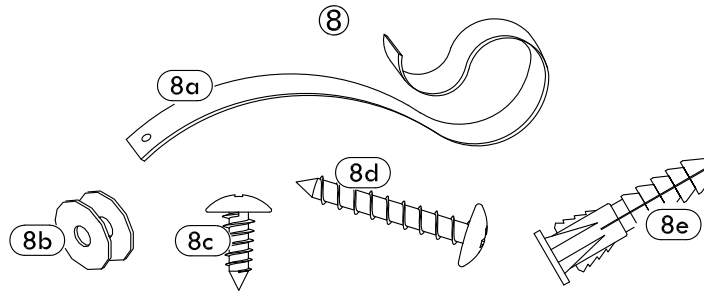

⑧
Safety strap kit
Qty: 1

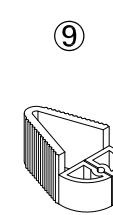

⑨
Nail holder
Qty: 1

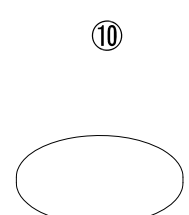

⑩
Sticker cover
Qty: 2

VERIFY THAT ALL PARTS ARE PRESENT BEFORE BEGINNING



We are available to assist you Monday -Friday
 from 9:00 am - 5:00 pm Eastern Standard Time.
1-800-729-1569
 USA only.

1

Insert long dowels ② into ③ & ④ panels.
Insert **two short** dowels ③ in one ⑤ panel.
Insert **four long** dowels ② in the remaining ⑤ panel.

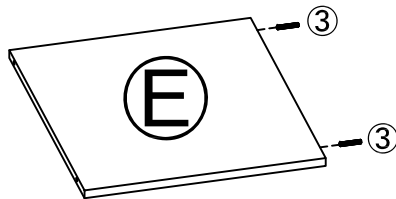
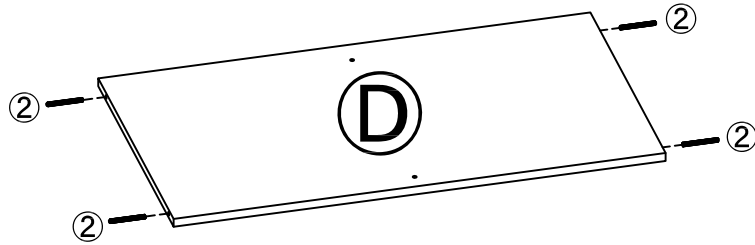
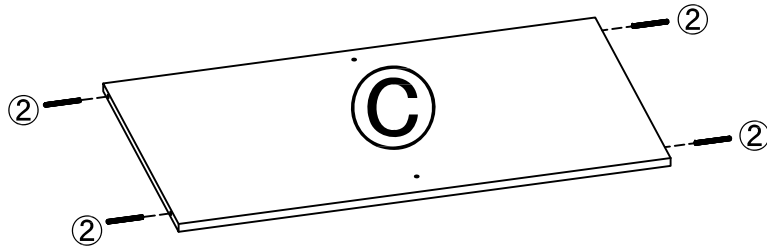

**“E” WITH SHORT
DOWELS IN ONE END**

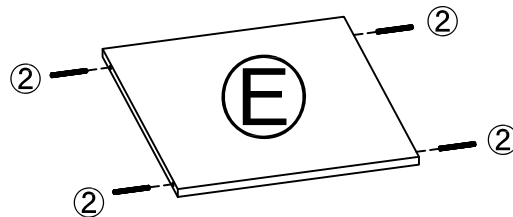

**“E” WITH LONG
DOWELS IN BOTH ENDS**

ADDITIONAL NOTES

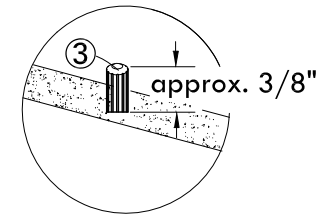
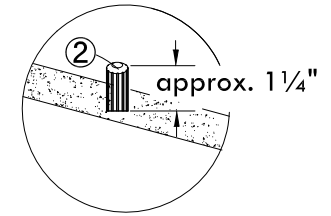

PARTS

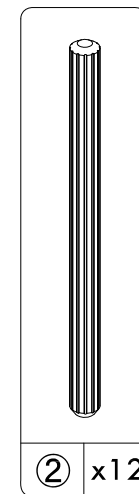
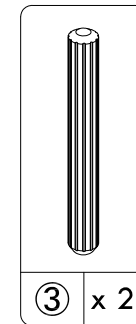

inch



2

Align and connect **E** panels to **C** & **D** panels.

PAY ATTENTION TO THE DIRECTION OF DOWELS IN E PANELS

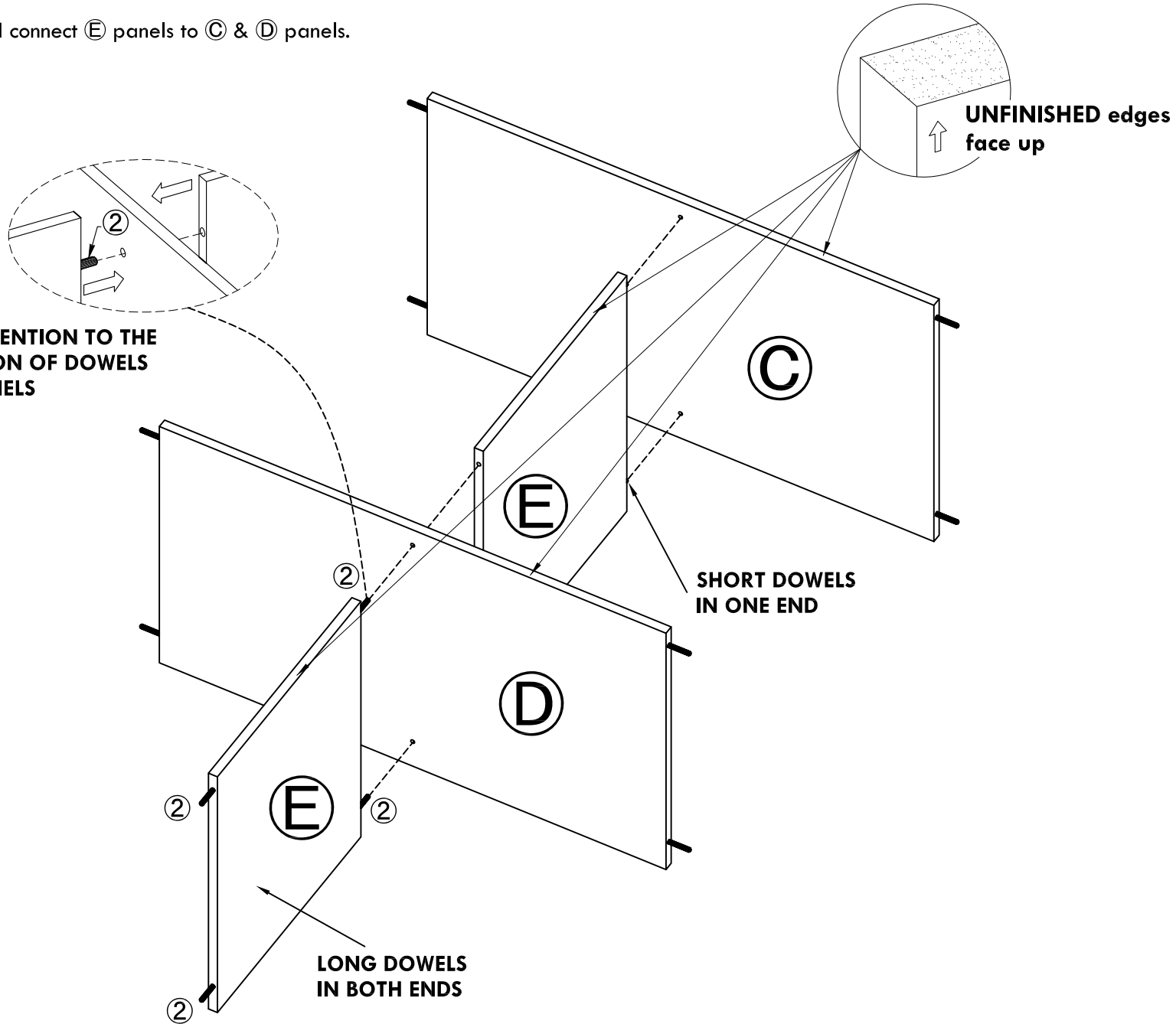

3

Connect **B** panels to structure.

⚠ WARNING

Do not move product until A (top/bottom) panels are attached. Failure to follow this could result in product damage and failure.

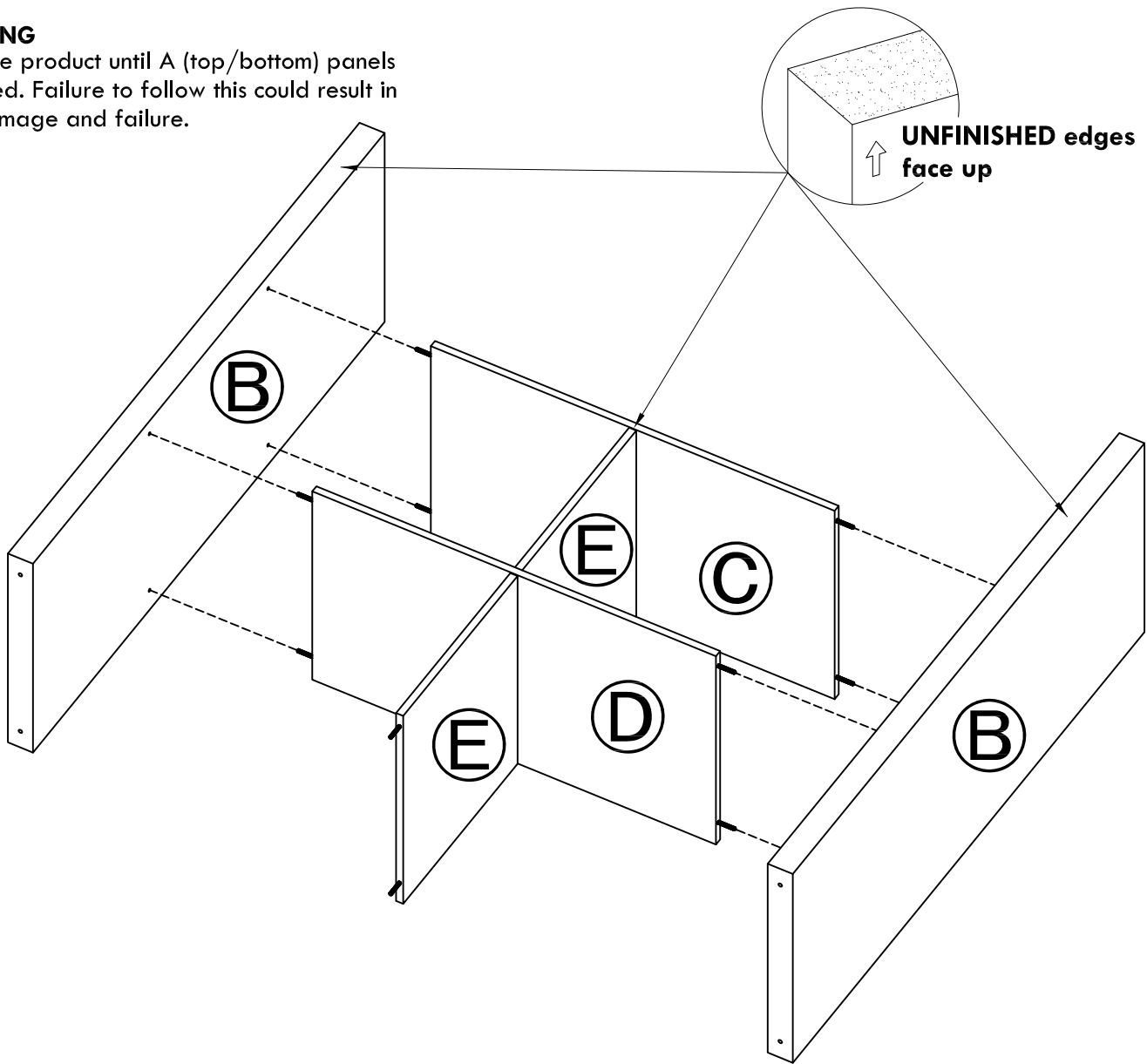

4

Use screw bolts ① to attach ① panels to structure.
 Use caps ⑦ to cover exposed screw heads in ① panels.
 Use stickers ⑩ to cover the exposed holes on top panel ①.

⚠ WARNING

Do not move product until A (top/bottom) panels are attached. Failure to follow this could result in product damage and failure.

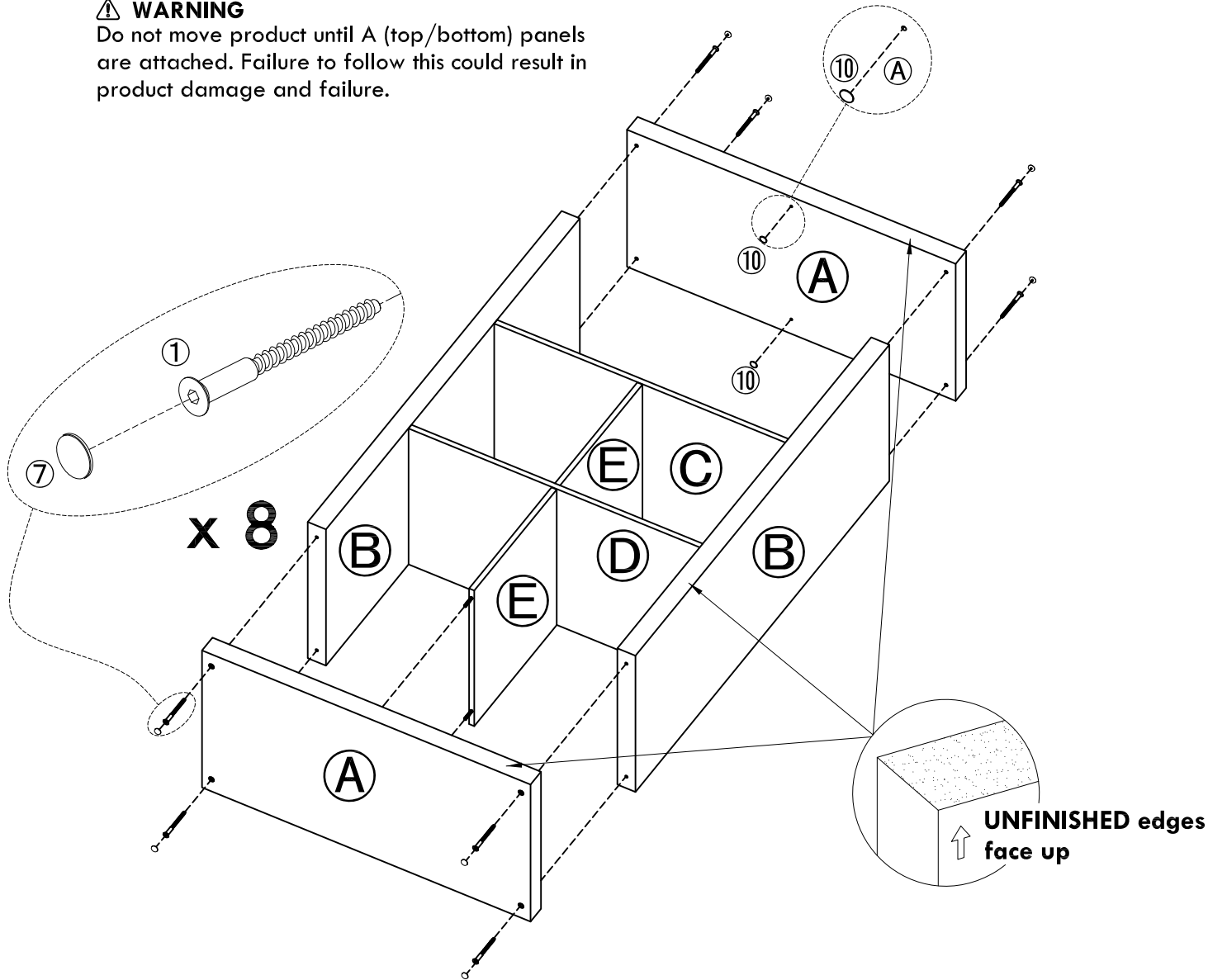

ADDITIONAL NOTES

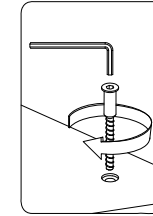

PARTS

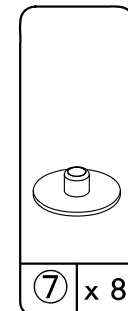
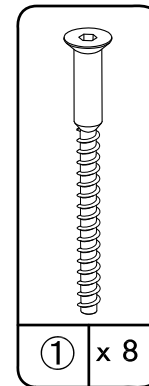
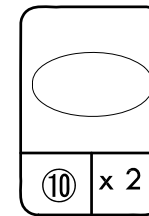

inch



5

Align back panels **F** & **G** to the unit and use nails **4** & nail holder **9** to attach back panels along the **outside edges only**.

Place a nail into the nail holder and slide the nail holder up to the side of the unit until flush. The nail will be positioned in the center of the particle board. Hammer the nail slightly into board, then slide nail holder back and hammer the nail in the rest of the way.

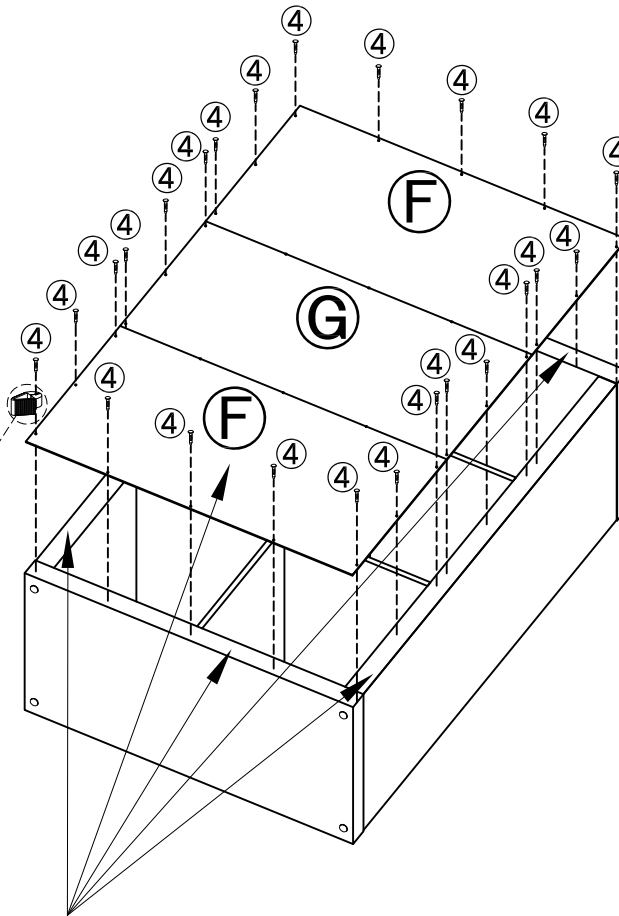
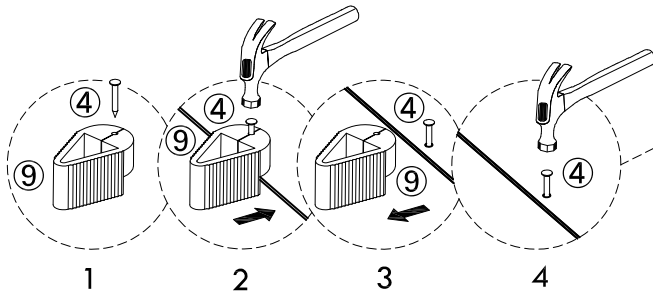

UNFINISHED edges & sides face up

CAUTION: Back panels must be attached before moving or using unit. Failure to attach back panels will result in instability.

PARTS

4 x 24	9 x 1

inch



6

Use screws ⑤ to attach back panels ① & ② along **inside edges** as shown.

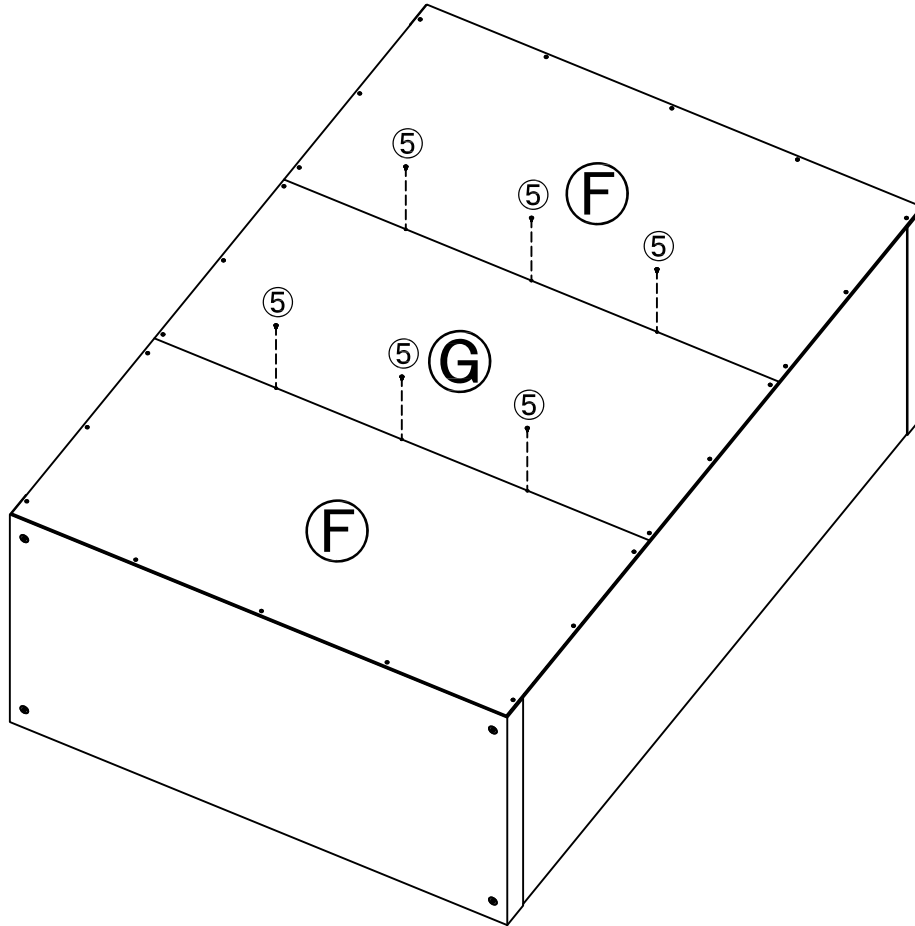

ADDITIONAL NOTES

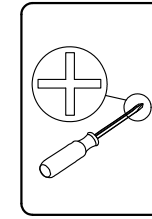

PARTS

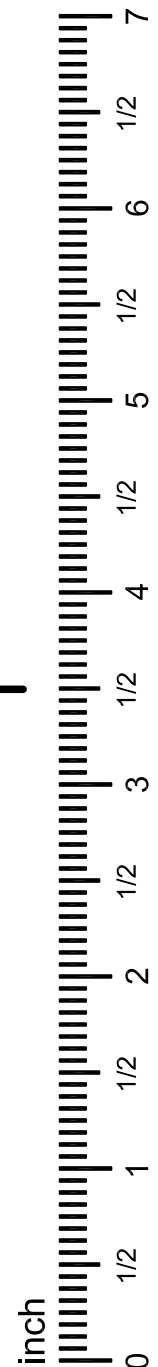
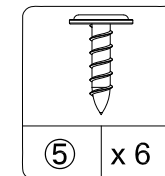

7

If unit is going to be used vertically, decide which end you want to be the top and attach wall strap (8a) using (8b) & (8c). Wall strap should be centered along the top edge of back panel (F).

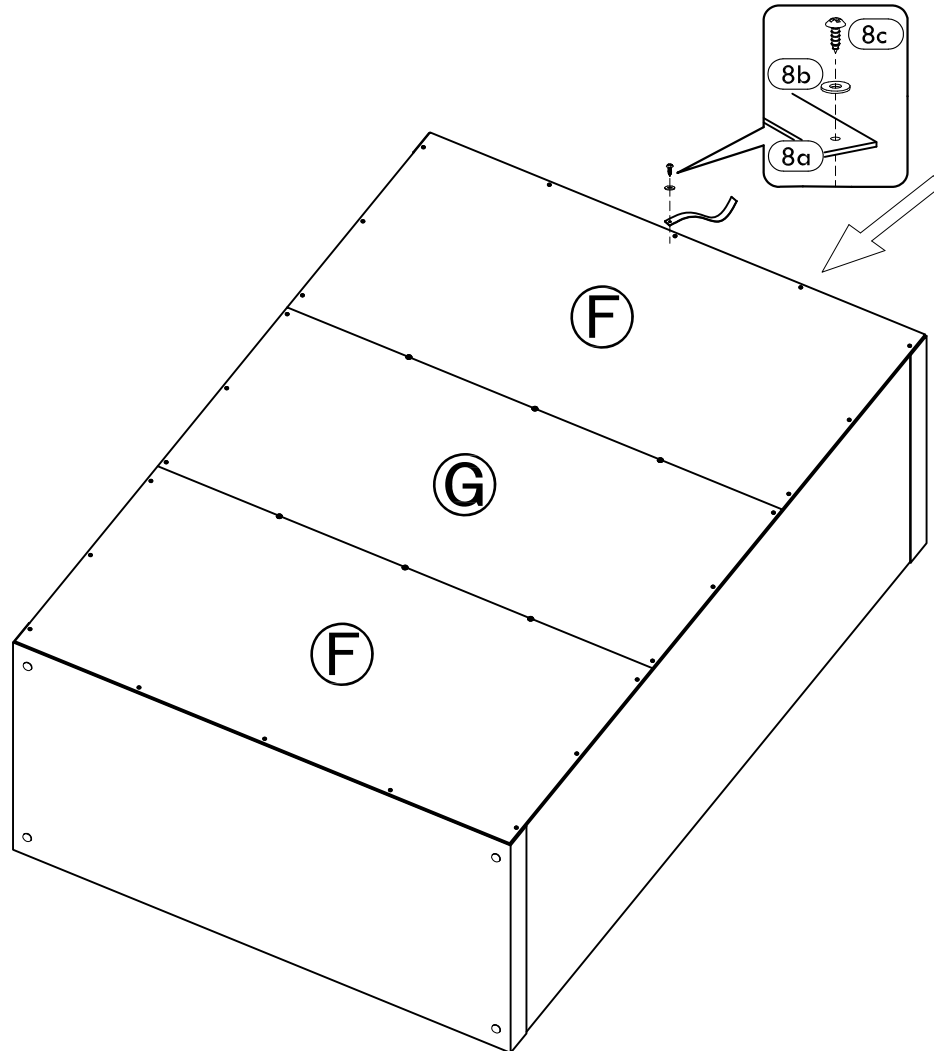

ADDITIONAL NOTES

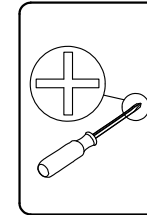

PARTS

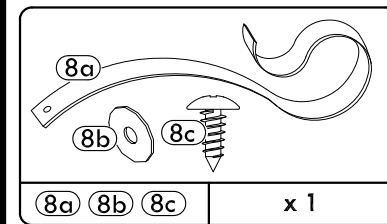

inch



8

Fasten safety strap to wall using Option 1 or Option 2 as shown below.

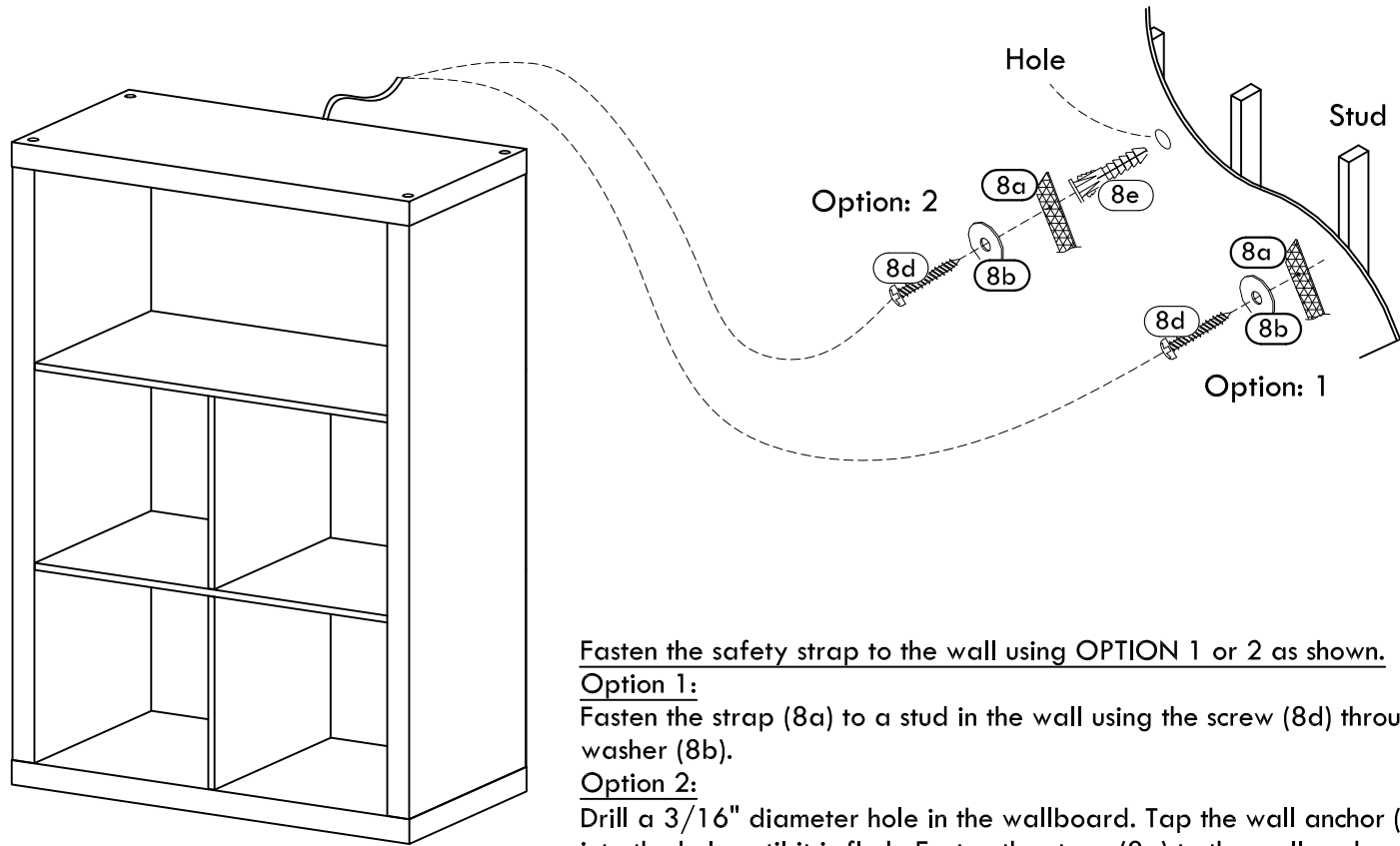

Fasten the safety strap to the wall using **OPTION 1** or **2** as shown.

Option 1:

Fasten the strap (8a) to a stud in the wall using the screw (8d) through washer (8b).

Option 2:

Drill a 3/16" diameter hole in the wallboard. Tap the wall anchor (8e) into the hole until it is flush. Fasten the strap (8a) to the wall anchor (8e) using the screw (8d) through the washer (8b).

ADDITIONAL NOTES

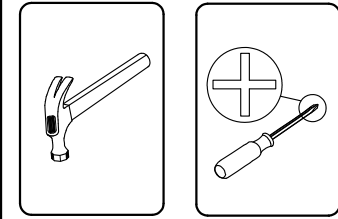

PARTS

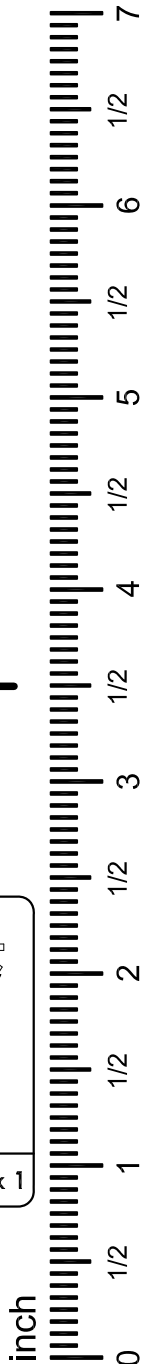
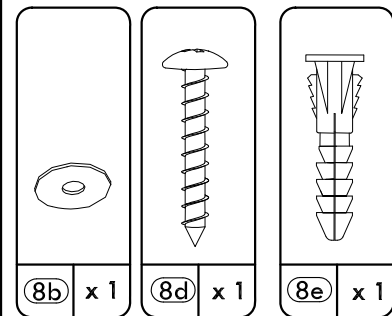

CONGRATULATIONS, YOUR UNIT IS COMPLETE, PLEASE ENJOY AND BE SURE TO TELL US ABOUT YOUR EXPERIENCE!

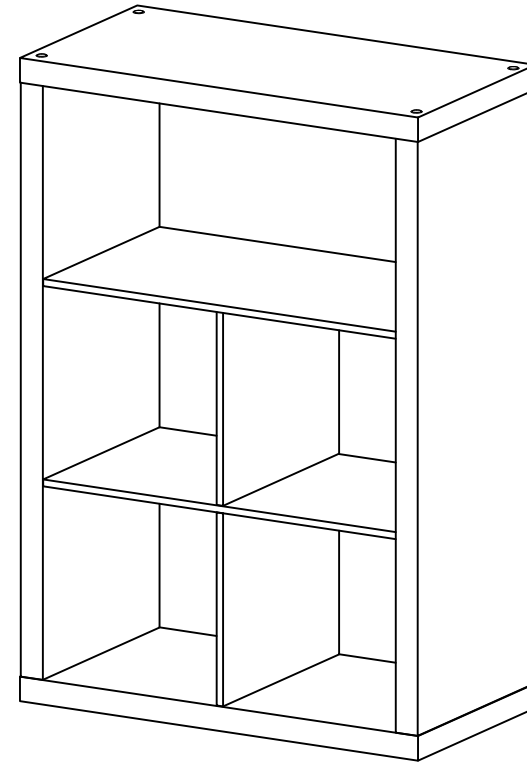
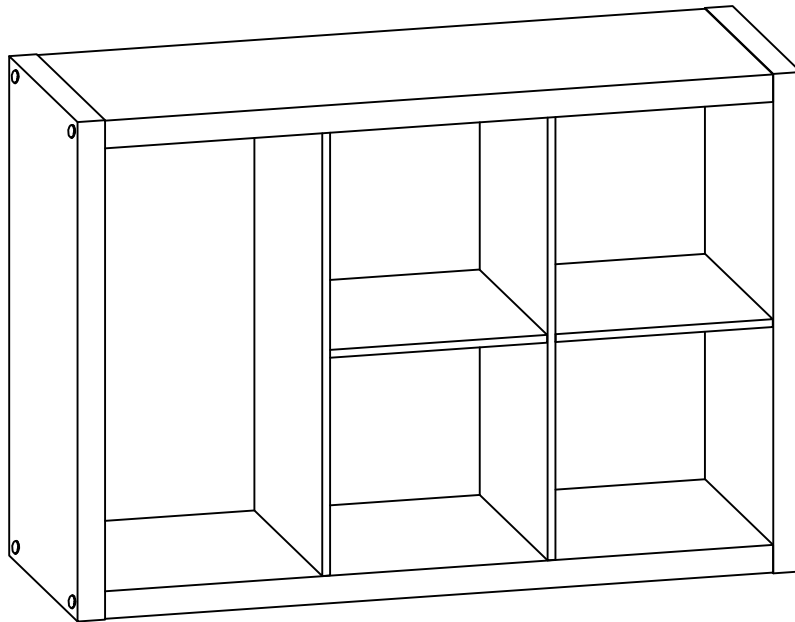

Quality Guarantee

Should this product be defective in workmanship or materials or fail under normal use, we will repair or replace it for up to (1) year from date of purchase.

This warranty gives you specific legal rights and you may also have other rights which vary from State to State.

**Please call for replacement parts or assistance: 1-800-729-1569
Monday - Friday 9:00 am - 5:00 pm EST**

BETTER HOMES & GARDENS ALMACENAMIENTO DE CUBO ABIERTO

NÚMERO DE STOCK DEL VENDEDOR
BH5336278612099-TEXTURA BLANCO
BH5336278612100-ROBLE TABACO
BH5336278612101-MIEL CLARA

ESTE PRODUCTO DEBE MONTARSE SIEMPRE EN
UNA PARED O EN UN EXTREMO PARA SU USO.

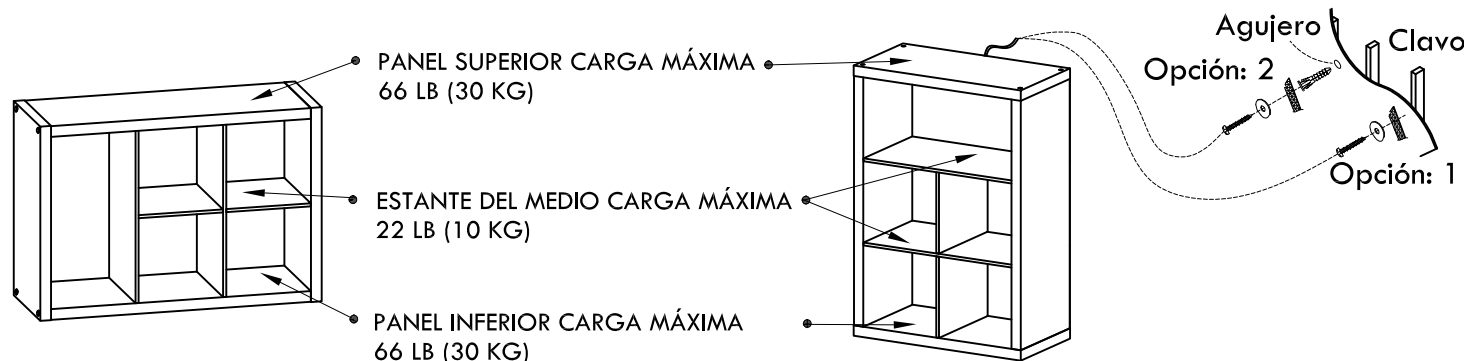

CONFIGURACIÓN OPCIONAL

NÚMERO DE PERSONAS RECOMENDADO PARA EL ENSAMBLAJE: 1
TIEMPO ESTIMADO DE ENSAMBLAJE: 1 HORA

- LLAME A NUESTRO NÚMERO GRATUITO **1-800-729-1569** PARA OBTENER MÁS AYUDA.
- PIEZAS ADICIONALES ESTÁN DISPONIBLES POR UNA TARIFA.
- ESTE MANUAL DE INSTRUCCIÓN CONTIENE INFORMACIÓN **IMPORTANTE** DE SEGURIDAD. POR FAVOR DE LEER Y GUARDAR PARA FUTURAS REFERENCIAS.
- NO DEJAR A LOS NIÑOS SUBIR O JUGAR SOBRE LA UNIDAD.
- LIMPIAR EL PRODUCTO CON TU PULIDOR FAVORITE DE MUEBLE Y UN TRAPO BLANDO.
- NO USAR QUÍMICOS FUERTES O PRODUCTO DE LIMPIEZA ABRASIVO.
- MUEVA SUS NUEVOS MUEBLES CUIDADOSAMENTE CON DOS PERSONAS, NUNCA EMPUJE O ARRASTRE LA UNIDAD.

NO DEVOLVER EL PRODUCTO A LA TIENDA.
TIENDAS INDIVIDUALES NO RESERVAN PIEZAS.
PARA PIEZAS PERDIDAS O DAÑADAS LLAME AL
1-800-729-1569.
PARTES SERÁN ENVIADOS DE FORMA GRATUITA.
PARA UN SERVICIO RÁPIDO Y CONFIABLE, POR
FAVOR DE TENER A MANO EL MANUAL DE
ENSAMBLAJE.

NÚMERO DE PARTIDA _____
FECHA DE COMPRA ____/____/____

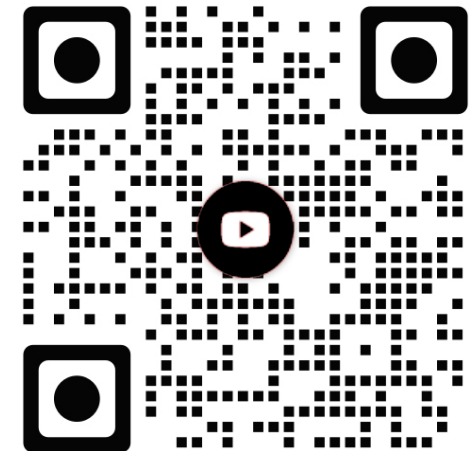

Abra su cámara y escanee el código
arriba para ver la guía de vídeo de
ensamblaje.

Megaprima Home Pte Ltd.
Diseñado en el E.E.U.U.
Hecho en Malaysia



Estamos disponibles para ayudarlo de Lunes - Viernes
de 9:00 am - 5:00 pm Hora de la Zona Este.
1-800-729-1569
Sólo E.E.U.U.

BETTER HOMES & GARDENS ALMACENAMIENTO DE CUBO ABIERTO

NÚMERO DE STOCK DEL VENDEDOR
BH5336278612099-TEXTURA BLANCO
BH5336278612100-ROBLE TABACO
BH5336278612101-MIEL CLARA



ANTES DE COMENZAR

- Leer y entender todos los pasos cuidadosamente antes de comenzar. Si no se sigue cada paso en el orden correcto, el montaje será difícil y puede ocasionar daños.
- Trabajar en una zona amplia, mejor sobre la alfombra, cerca del sitio donde la unidad se utiliza.
- Asegurarse de que todas las piezas estén incluidos. La mayoría de los tableros están etiquetados con una pegatina removible.

Consejos útiles

- Llamar a nuestro número gratis para ayuda. Estamos disponibles para ayudarlo de lunes - Viernes de 9:00 am - 5:00 pm hora de la zona este.
- **1-800-729-1569** Sólo E.E.U.U.
O haga una solicitud a través de nuestro portal de autoservicio en www.huisenfurniture.zendesk.com

HERRAMIENTAS NECESARIAS PARA ENSAMBLAR

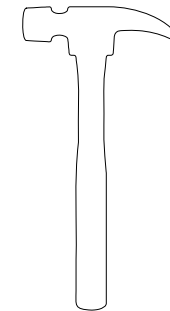

martillo



destornillador de
cabeza phillips



**NO UTILICE HERRAMIENTAS ELÉCTRICAS
PARA MONTAR SUS MUEBLES.
HERRAMIENTAS ELÉCTRICAS PUEDEN
PROVOCAR DAÑOS.**

Megaprima Home Pte Ltd.
Diseñado en el E.E.U.U.
Hecho en Malaysia



Estamos disponibles para ayudarlo de Lunes - Viernes
de 9:00 am - 5:00 pm Hora de la Zona Este.
1-800-729-1569
Sólo E.E.U.U.

BETTER HOMES & GARDENS ALMACENAMIENTO DE CUBO ABIERTO

NÚMERO DE STOCK DEL VENDEDOR
BH5336278612099-TEXTURA BLANCO
BH5336278612100-ROBLE TABACO
BH5336278612101-MIEL CLARA

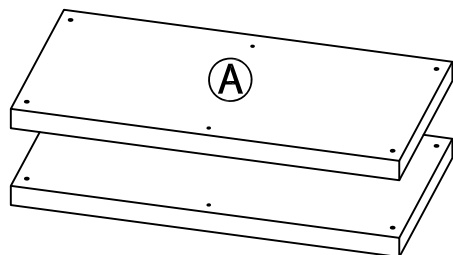

Panel superior/Inferior
(Cantidad: 2)

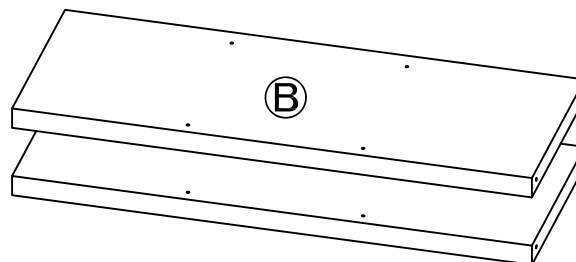

Panel lateral
(Cantidad: 2)

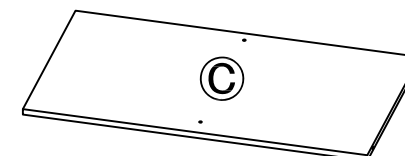

Estante del medio 1
(Cantidad: 1)

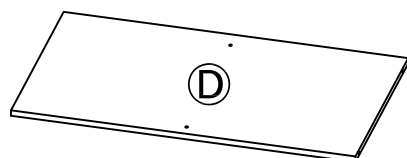

Estante del medio 2
(Cantidad: 1)



Tabla de tabique
(Cantidad: 2)



Panel posterior 1
(Cantidad: 2)

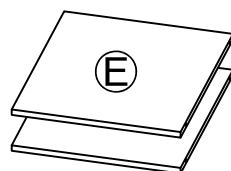
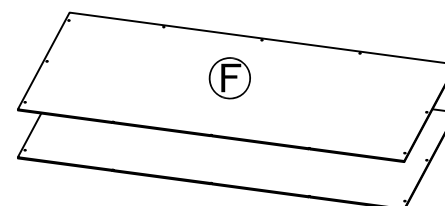
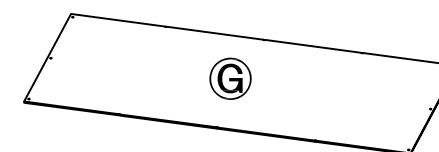

Panel posterior 2
(Cantidad: 1)

**VERIFIQUE QUE TODAS LAS PIEZAS ESTÉN EN LA LISTA ANTES
DE COMENZAR**



Estamos disponibles para ayudarlo de Lunes - Viernes
de 9:00 am - 5:00 pm Hora de la Zona Este.
1-800-729-1569
Sólo E.E.U.U.

BETTER HOMES & GARDENS ALMACENAMIENTO DE CUBO ABIERTO

NÚMERO DE STOCK DEL VENDEDOR
BH5336278612099-TEXTURA BLANCO
BH5336278612100-ROBLE TABACO
BH5336278612101-MIEL CLARA

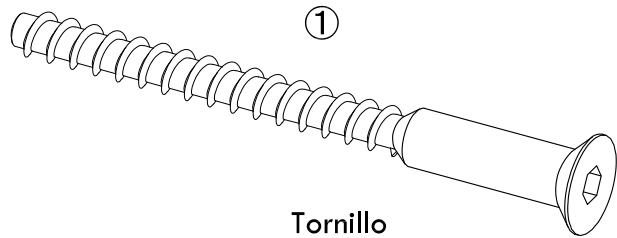

①
Tornillo
Cantidad: 8

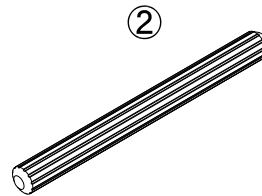

②
Clavija largas
Cantidad: 12

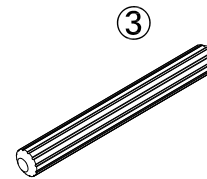

③
Clavija cortas
Cantidad: 2

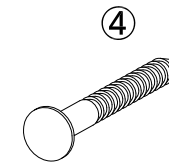

④
Clavo
Cantidad: 24+1 Extra

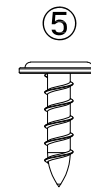

⑤
Tornillo
Cantidad: 6

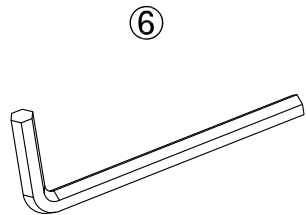

⑥
Llave allen
Cantidad: 1

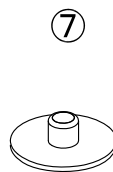

⑦
Tapón
Cantidad: 8+1 Extra

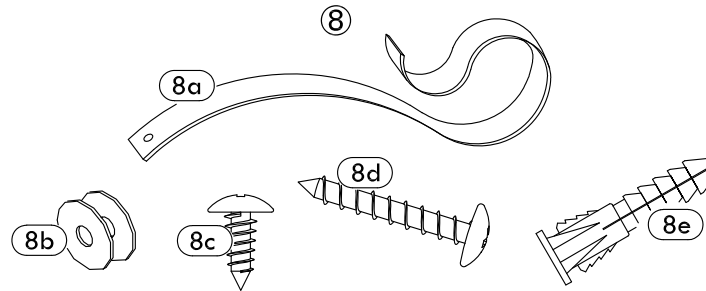

⑧
Cinturón
Cantidad: 1

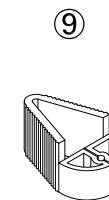

⑨
Soporte de clavo
Cantidad: 1

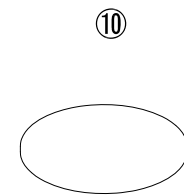

⑩
Cubierta pegatina
Cantidad: 2

VERIFIQUE QUE TODAS LAS PIEZAS ESTÉN EN LA LISTA ANTES DE COMENZAR



Estamos disponibles para ayudarlo de Lunes - Viernes de 9:00 am - 5:00 pm Hora de la Zona Este.
1-800-729-1569
Sólo E.E.U.U.

1

Insertar clavijas largas ② en el paneles ③ y ④.
Insertar **dos clavijas cortas** ③ en un paneles ⑤.
Insertar **cuatro clavijas largas** ② en restante paneles ⑤.

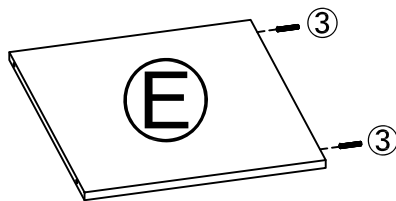
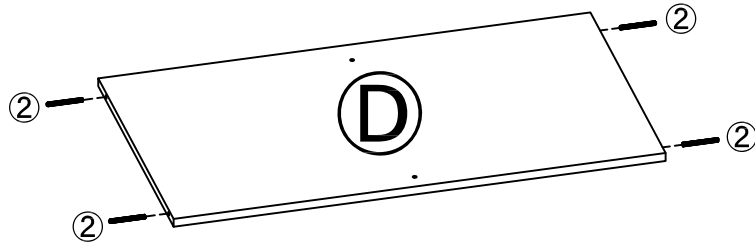
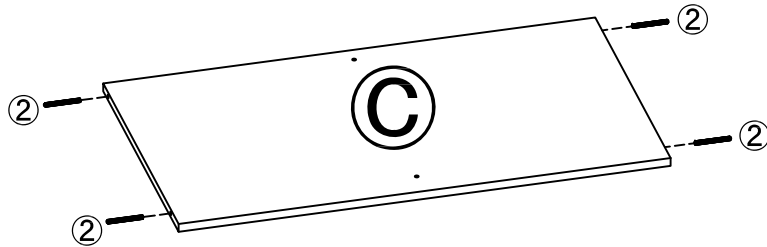

"E" CON CLAVIJAS CORTO EN UN EXTREMO

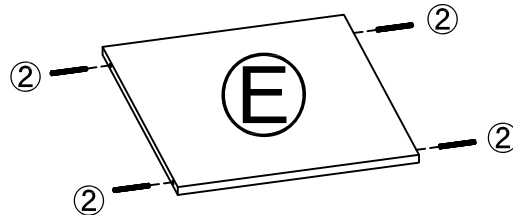

"E" CON CLAVIJAS LARGO EN UN EXTREMO

NOTAS ADICIONALES

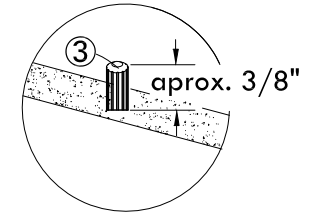
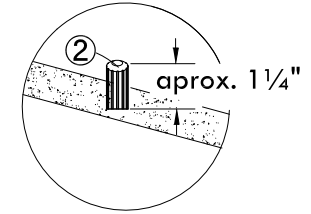

PARTES

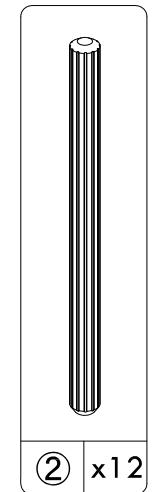
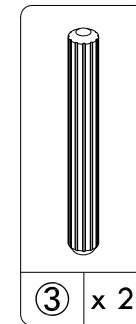

inch



2

Alinee y conectar la paneles **E** entre los paneles **C** y paneles **D**.

POR FAVOR DE PRESTAR ATENCIÓN A LA DIRECCIÓN DE LAS CLAVIJAS EN PANELES E.

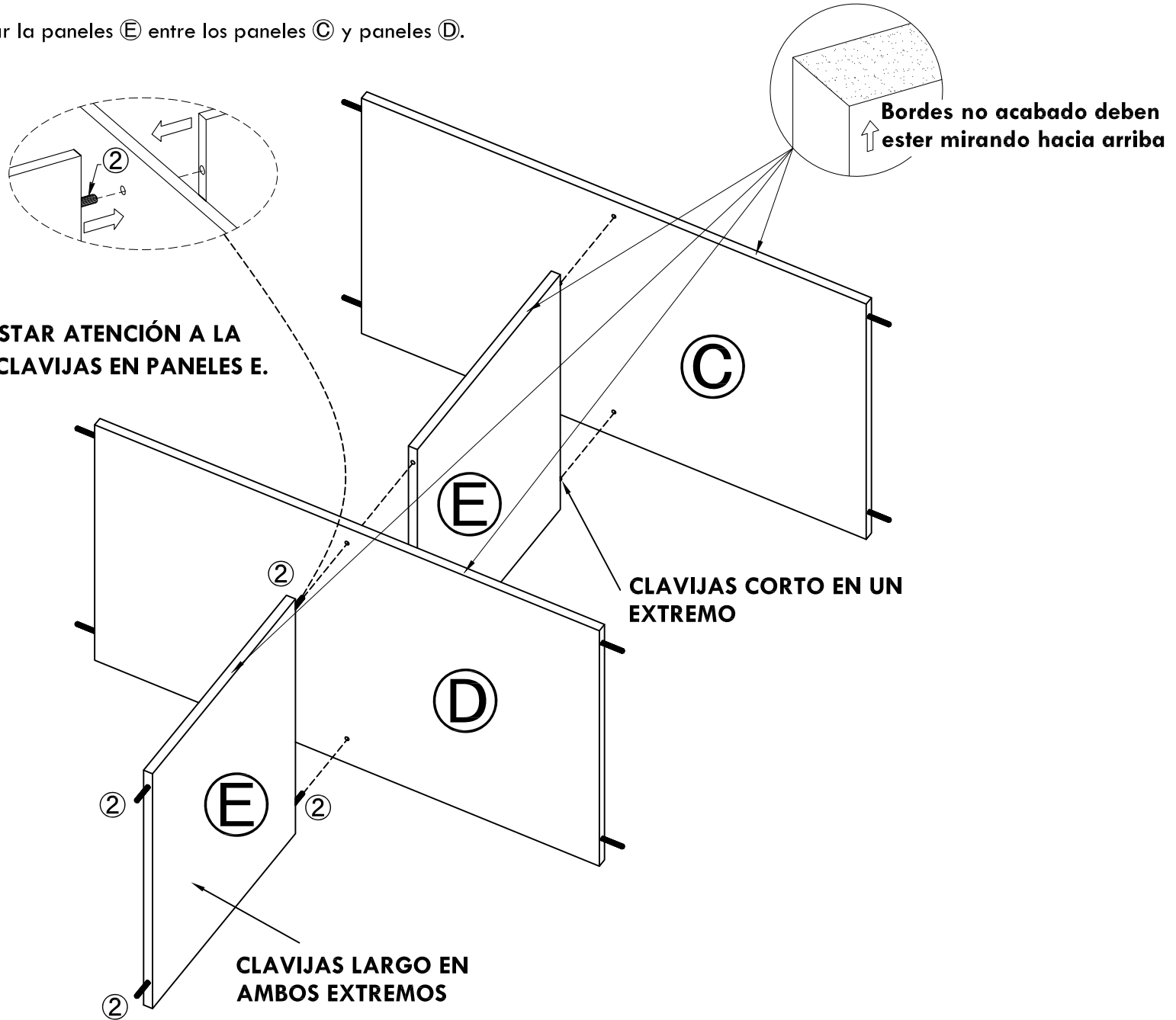

3

Conectar la **B** panel a estructura.

⚠ ADVERTENCIA

Este producto no se moverá hasta que los paneles A (superior y inferior) panel estén unidos. El incumplimiento de esto puede ocasionar daños y fallas en el producto.

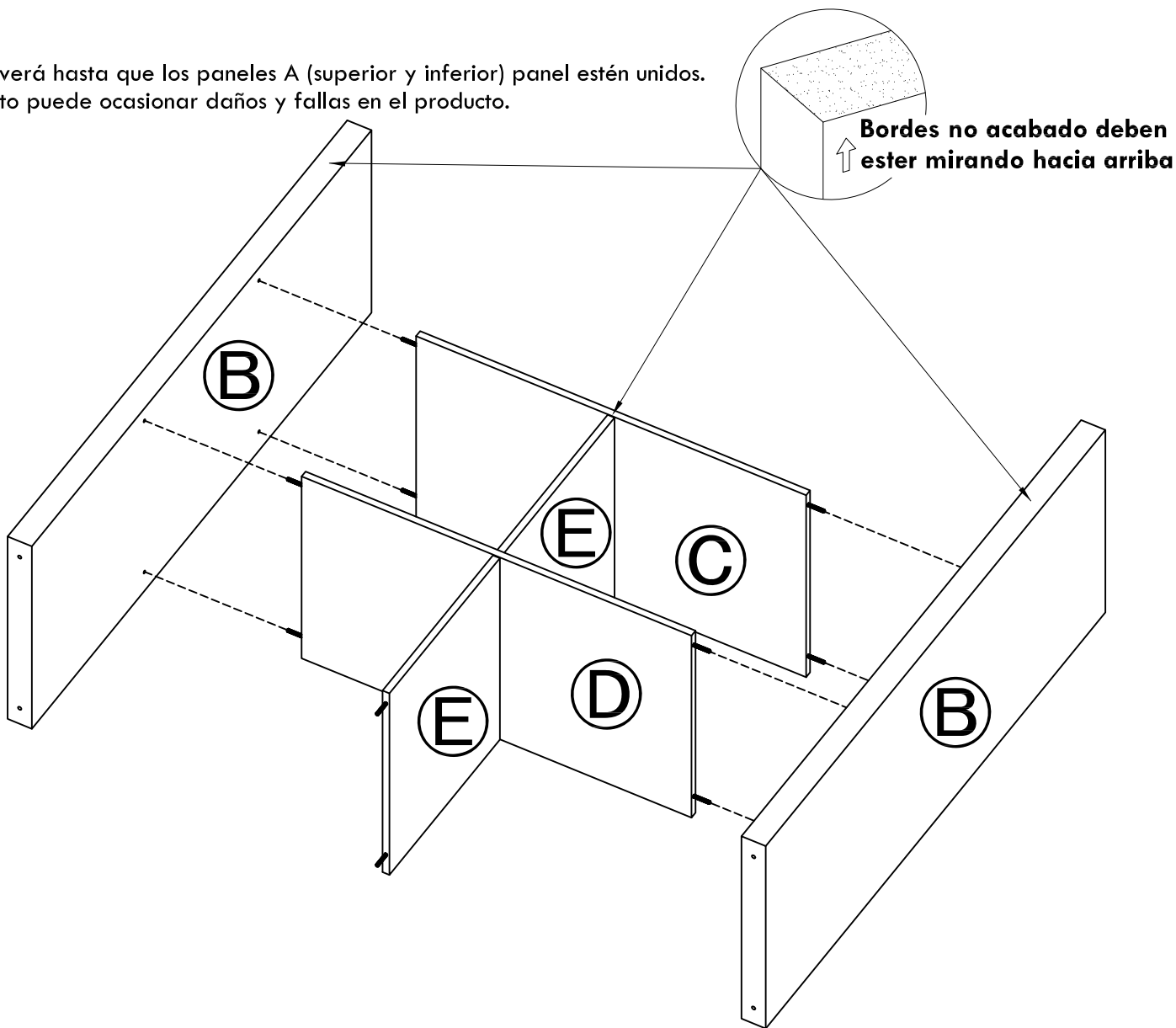

- 4** Utilice el tornillo ① para fijar el ① paneles a estructura.
 Utilice la tapón ⑦ para cubrir los cabezas el tornillo expuestos en el ① paneles.
 Utilice la pegatinas ⑩ para cubrir los hoyos expuestos en el paneles superior ①.

⚠ ADVERTENCIA

Este producto no se moverá hasta que los paneles A (superior y inferior) panel estén unidos.
 El incumplimiento de esto puede ocasionar daños y fallas en el producto.

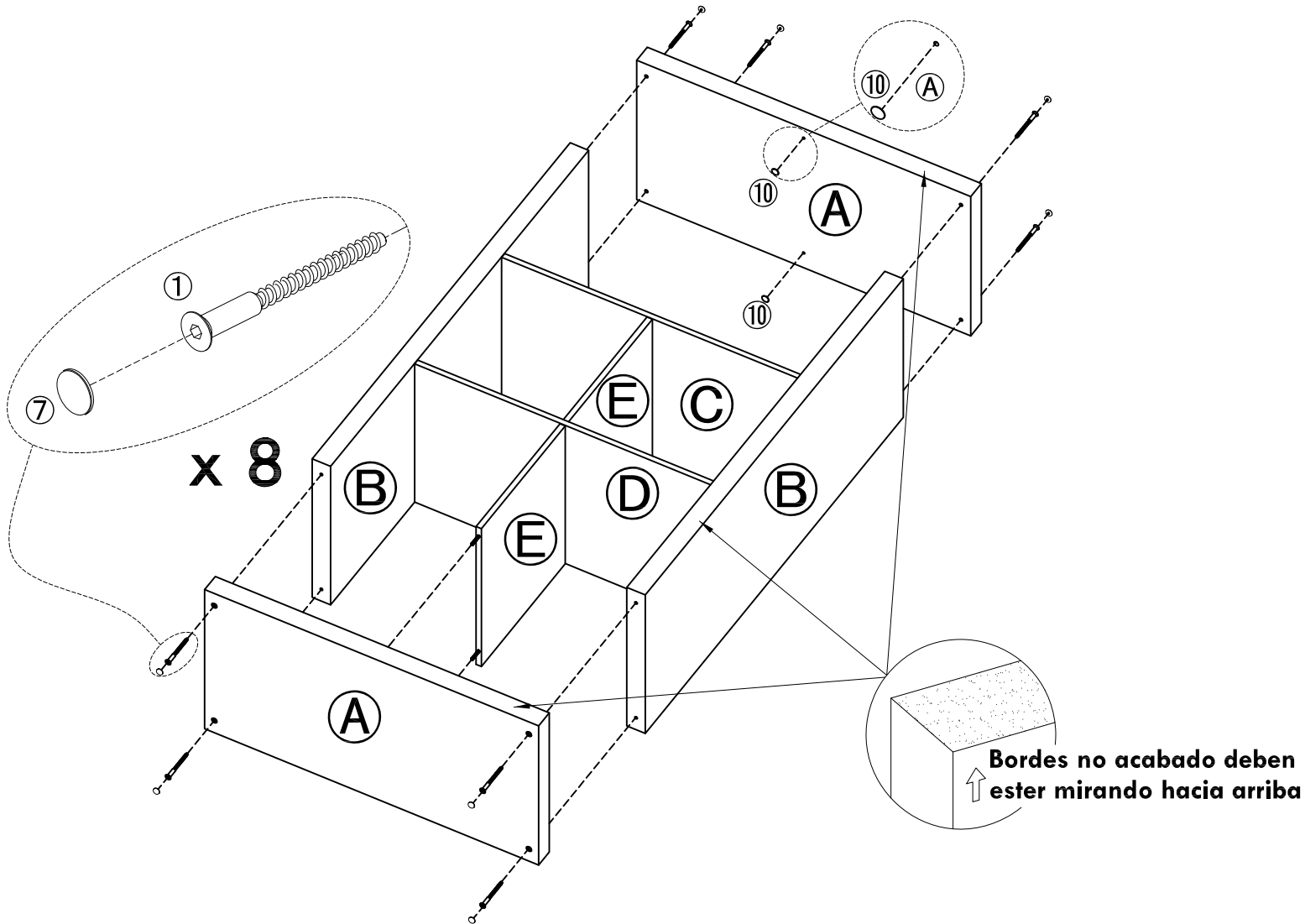

NOTAS ADICIONALES

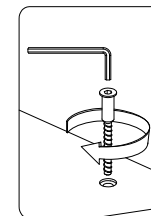

PARTES

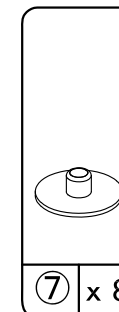
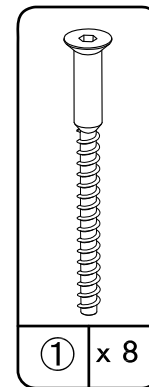
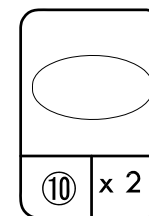

inch

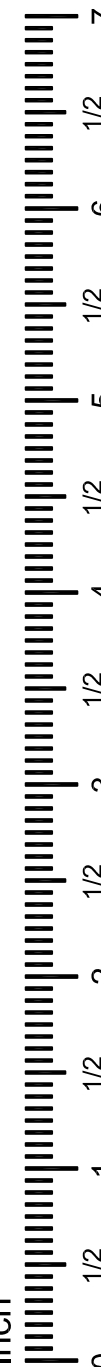

5

Alinee los paneles posterior (F) y (G) al conjunto, y sólo fije los paneles posterior a lo largo de **bordes exteriores** con clavos (4) y soporte de clavo (9).

Coloque un clavo en el soporte de clavos y deslice el soporte hacia el borde de la unidad hasta que quede al ras. El clavo se colocará en el centro del tablero de partículas. Martille el clavo ligeramente en el tablero, luego deslice el soporte hacia atrás y martille el resto de clavo.

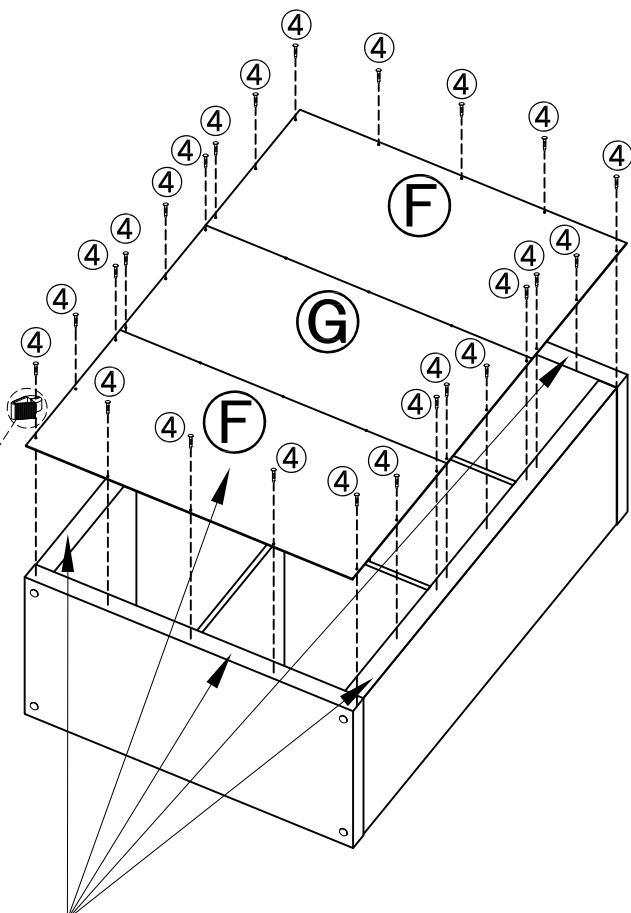
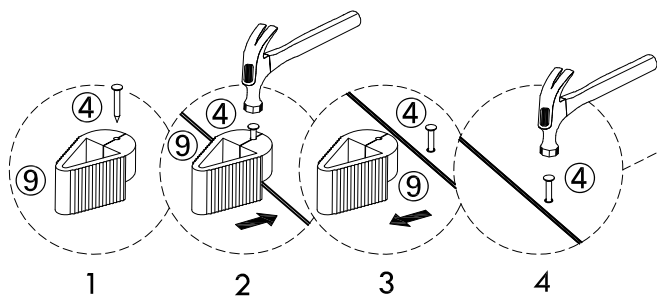

PRECAUCIÓN: Los paneles traseros deben fijarse antes de mover o utilizar la unidad. El fallo de fijarse los paneles traseros resultará en inestabilidad.

Bordes & lado no acabado deben estar mirando hacia arriba

PARTES

	x 24		x 1
--	------	--	-----

inch



6

Fije los paneles posterior (F) & (G) a lo largo de **bordes interiores** con tornillos (5) como se muestra.

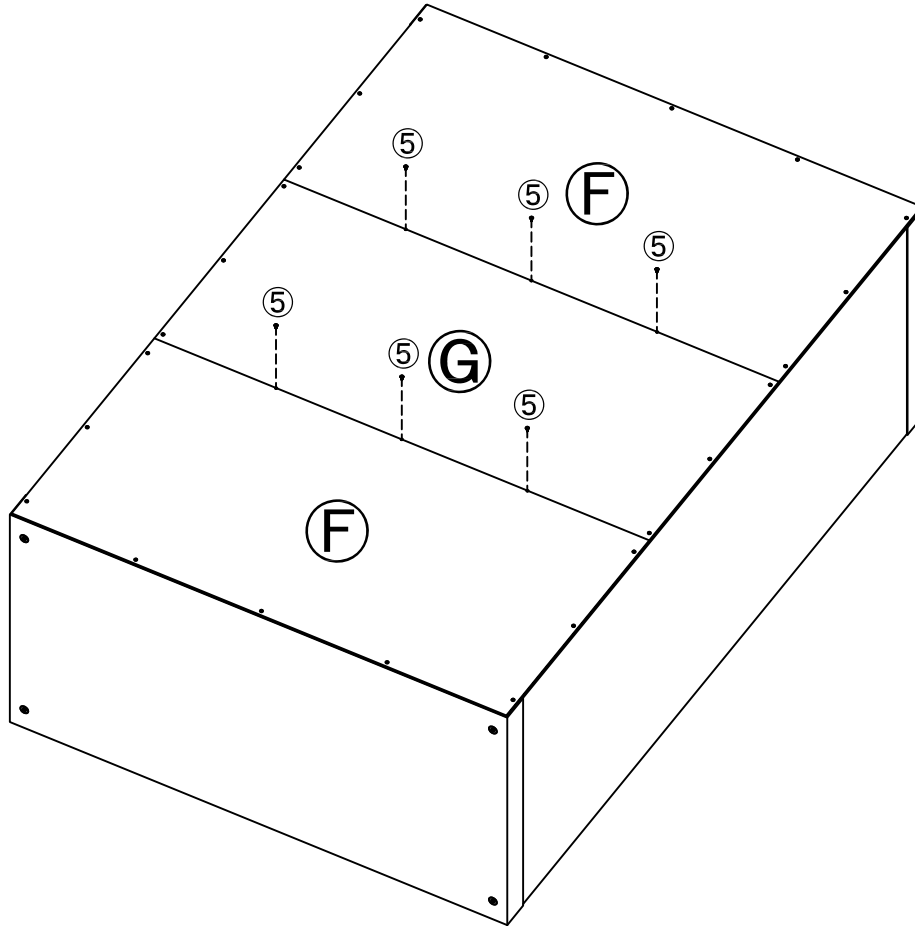

NOTAS ADICIONALES

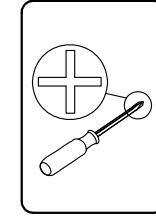

PARTES

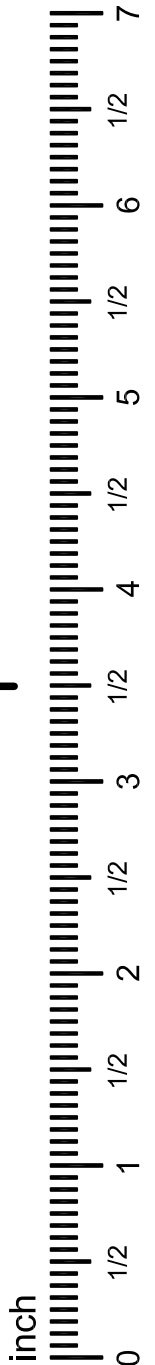
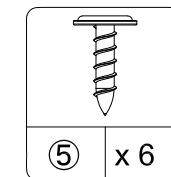

7

Si el conjunto se va a usar verticalmente, decida cuál de los extremos quiera que sea el superior, y fije la tira (8a) a la pared con (8b) y (8c). La tira tiene que ser centrada por el borde superior del panel posterior (F).

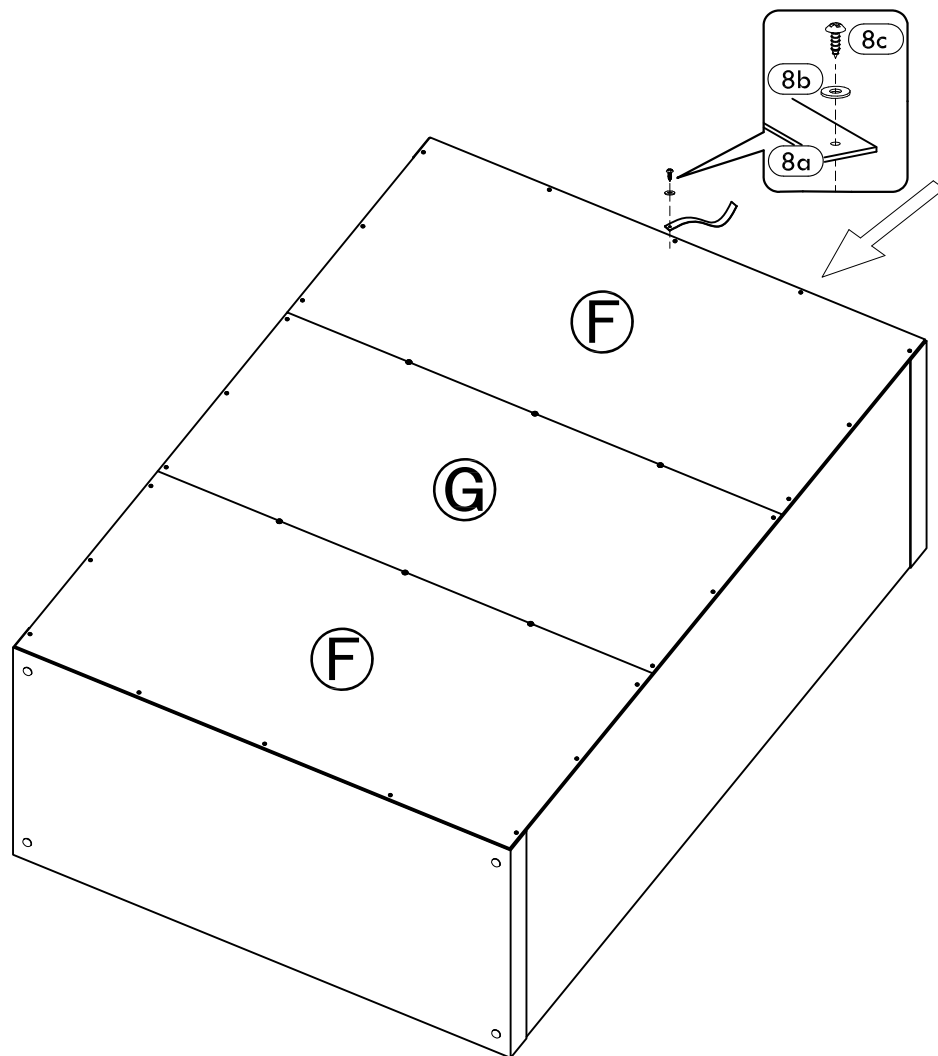

NOTAS ADICIONALES

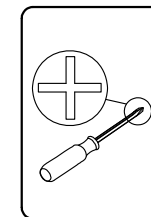

PARTES

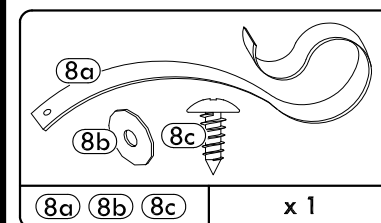

inch

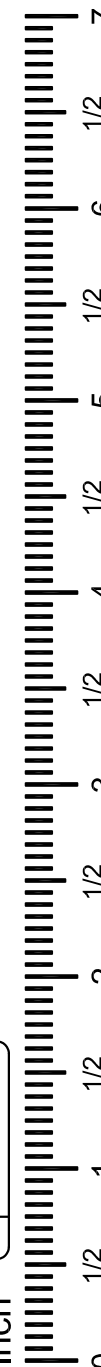

8

Abrochar el cinturón con la pared usando Opción 1 o Opción 2 muestra a continuación.

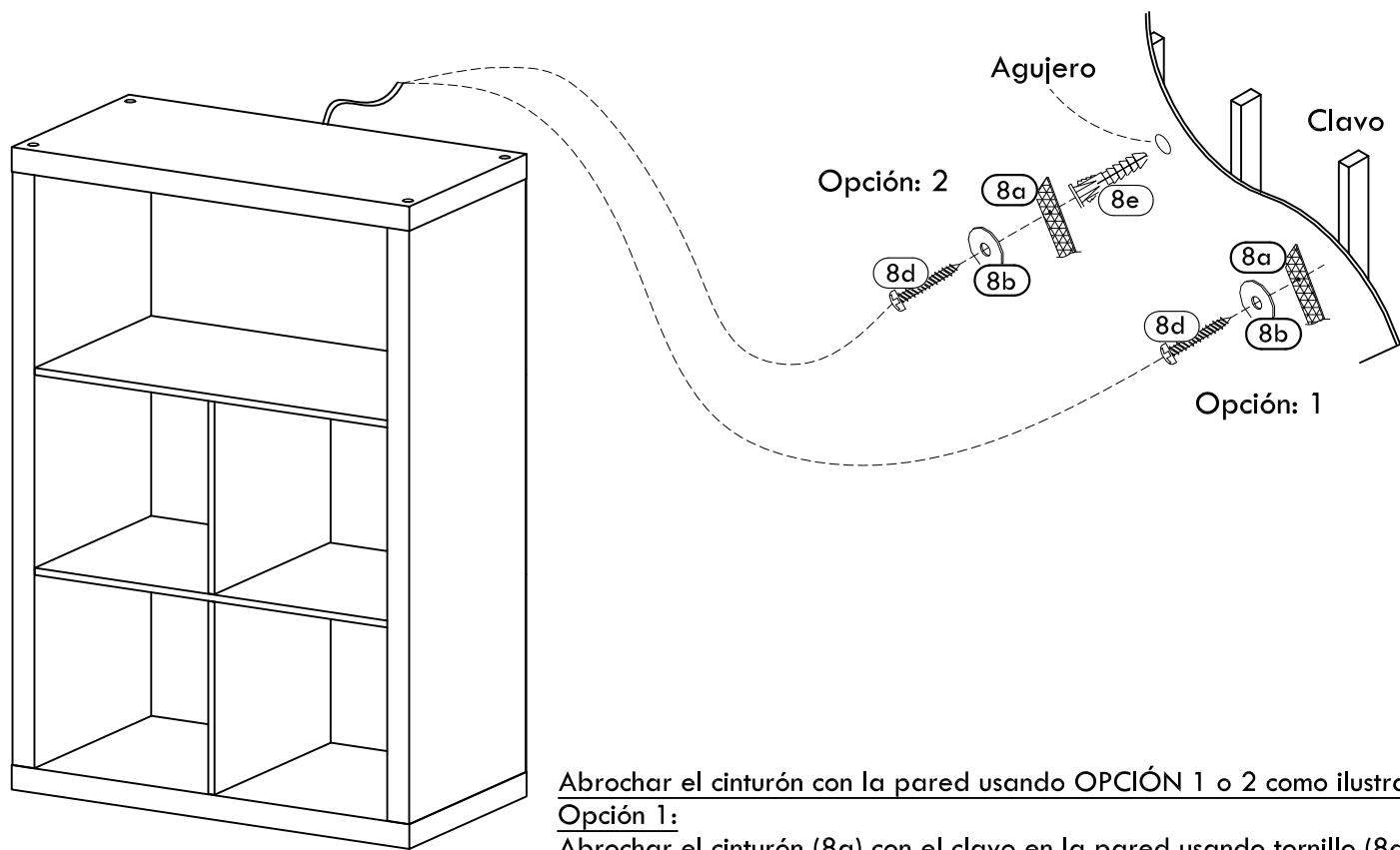

Abrochar el cinturón con la pared usando OPCIÓN 1 o 2 como ilustrado.

Opción 1:

Abrochar el cinturón (8a) con el clavo en la pared usando tornillo (8d) a través de arandela (8b).

Opción 2:

Perforar un agujero de diámetro 3/16" en la barra. Espitar la ancla de pared (8e) en el agujero hasta que es quede al mismo nivel. Fijar el cinturón (8a) con la ancla de pared (8e) usando el tornillo (8d) a través de la arandela (8b).

NOTAS ADICIONALES

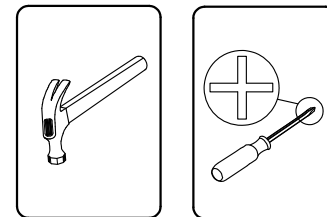

PARTES

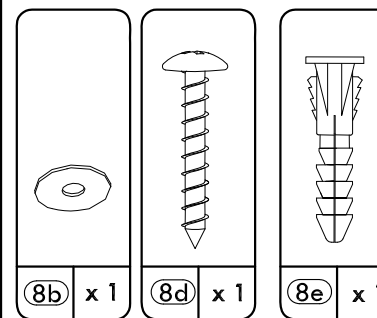

(8b) x 1

(8d) x 1

(8e) x 1

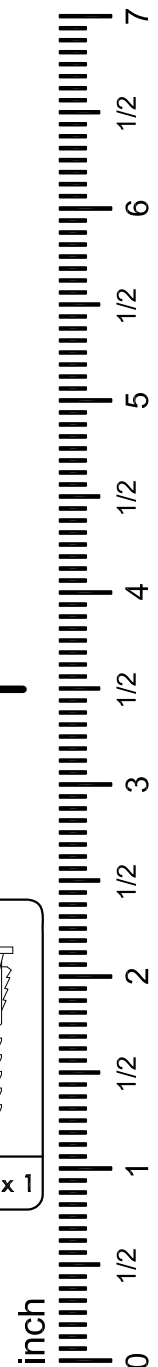

ENHORABUENA, SU ACCESORIO ESTÁ COMPLETO, ¡DISFRUTE Y NO DEJE DE CONTARNOS SU EXPERIENCIA!

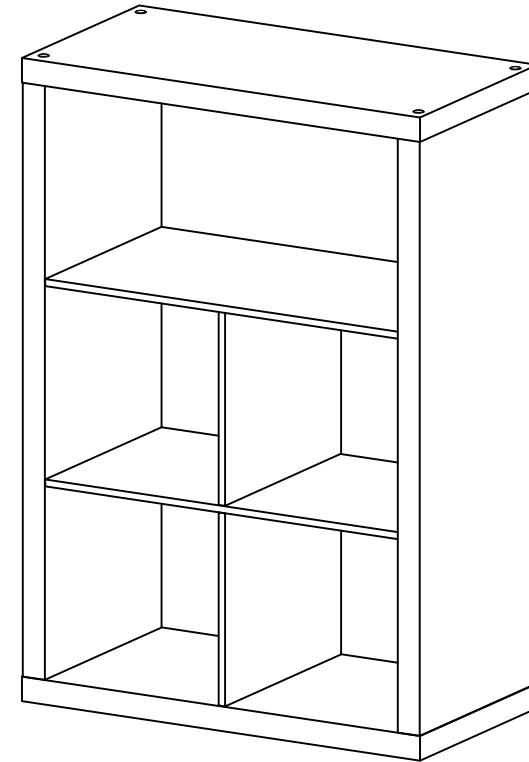
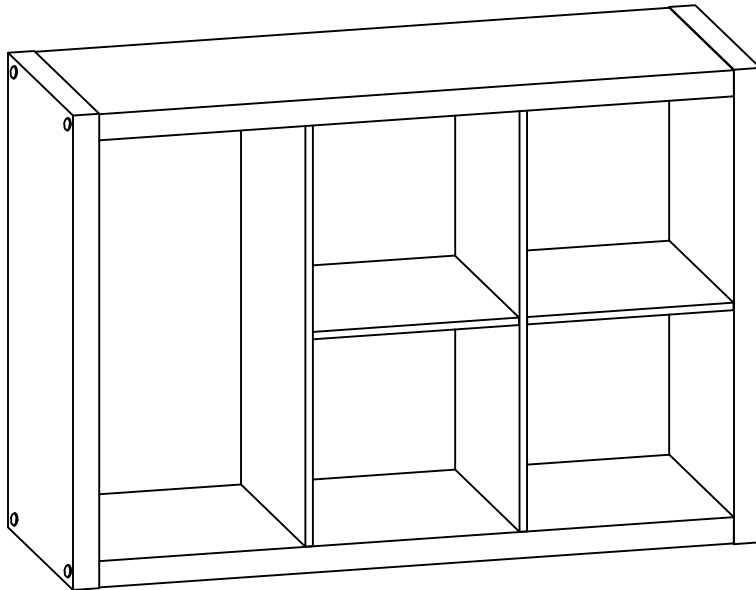

Garantía de Calidad

Si este producto presenta defectos de fabricación o de materiales o se cae bajo usos normales, lo arreglaremos o sustituiremos por hasta (1) año desde la fecha de compra.

Esta garantía te otorga derechos legales específicos y tú también tienes otros derechos que varían de un Estado a otro.

**Por favor de llamarnos para piezas de reemplazo o ayudas: 1-800-729-1569
Lunes - Viernes 9:00 am - 5:00 pm EST**