

MAINSTAYS 8-CUBE ORGANIZER

VENDOR STOCK NUMBERS
MS18-D1-1009-51-RUSTIC BROWN
MS18-D1-1009-52-CANYON WALNUT

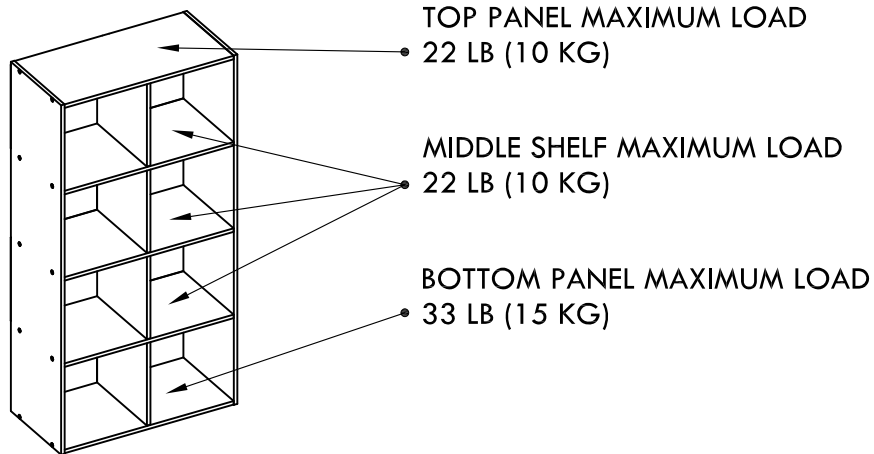

RECOMMENDED NUMBER OF PEOPLE FOR ASSEMBLY: 1
ESTIMATED ASSEMBLY TIME: 1 HOUR

- CALL OUR TOLL FREE NUMBER **1-800-729-1569** FOR FURTHER ASSISTANCE.
- ADDITIONAL PARTS ARE AVAILABLE FOR A FEE.
- THIS INSTRUCTION BOOKLET CONTAINS **IMPORTANT** SAFETY INFORMATION. PLEASE READ AND KEEP FOR FUTURE REFERENCE.
- DO NOT ALLOW CHILDREN TO CLIMB OR PLAY ON THE UNIT.
- CLEAN THE PRODUCT WITH YOUR FAVORITE FURNITURE POLISH AND A SOFT CLOTH.
- DO NOT USE HARSH CHEMICALS OR ABRASIVE CLEANERS.
- MOVE YOUR NEW FURNITURE CAREFULLY WITH TWO PEOPLE. NEVER PUSH OR DRAG THE UNIT.

**DO NOT RETURN THE PRODUCT TO THE STORE.
INDIVIDUAL STORES DO NOT STOCK PARTS.
FOR MISSING OR DAMAGED PARTS CALL
1-800-729-1569.
PARTS WILL BE SHIPPED FREE OF CHARGE.**

**FOR PROMPT, RELIABLE SERVICE, PLEASE HAVE
YOUR ASSEMBLY MANUAL READY.**

LOT NUMBER _____
DATE OF PURCHASE ___/___/___

Huisen Furniture (Longnan) Co.,Ltd.
Designed in the USA
Made in China



We are available to assist you Monday -Friday
from 9:00 am - 5:00 pm Eastern Standard Time.
1-800-729-1569
USA only.

MAINSTAYS 8-CUBE ORGANIZER

VENDOR STOCK NUMBERS
MS18-D1-1009-51-RUSTIC BROWN
MS18-D1-1009-52-CANYON WALNUT



BEFORE STARTING

- Read and understand all the steps carefully before starting. If each step is not followed in the correct order the assembly will be difficult and may result in damages.
- Work in a spacious area, preferably on a carpeted surface, near where the unit will be used.
- Make sure all the parts are included. Most boards are labeled with a removable sticker.

Helpful hints

- Call our toll free number if you need assistance. We are available to assist you Monday - Friday from 9:00 am - 5:00 pm Eastern Standard Time.
- **1-800-729-1569** USA only.
Or submit a request through our self-service portal at www.huisenfurniture.zendesk.com

TOOLS NEEDED TO ASSEMBLE

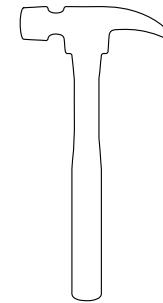

hammer



phillips head
screwdriver



DO NOT USE POWER TOOLS TO ASSEMBLE YOUR FURNITURE. POWER TOOLS MAY DAMAGE THE PARTS AND RESULT IN DAMAGE.

Huisen Furniture (Longnan) Co.,Ltd.
Designed in the USA
Made in China



We are available to assist you Monday -Friday from 9:00 am - 5:00 pm Eastern Standard Time.
1-800-729-1569
USA only.

MAINSTAYS 8-CUBE ORGANIZER

VENDOR STOCK NUMBERS
MS18-D1-1009-51-RUSTIC BROWN
MS18-D1-1009-52-CANYON WALNUT

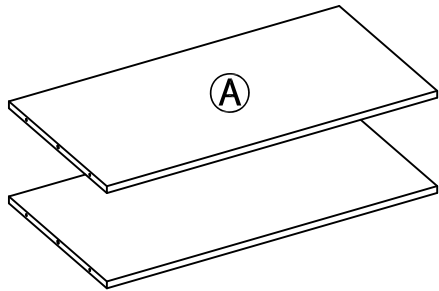

Top/bottom panel
(Qty: 2)

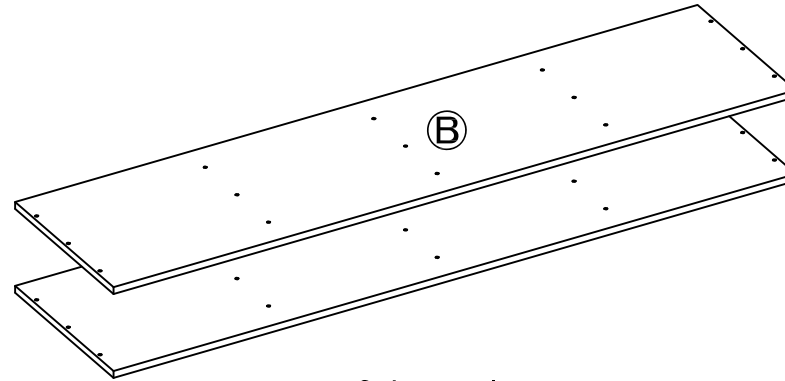

Side panel
(Qty: 2)

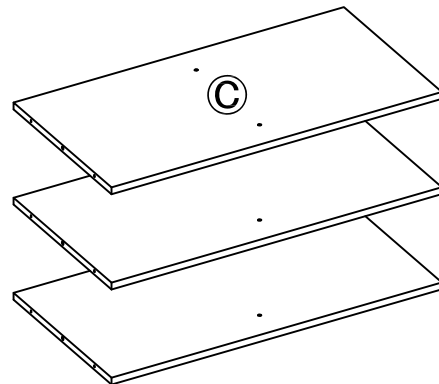

Middle shelf
(Qty: 3)

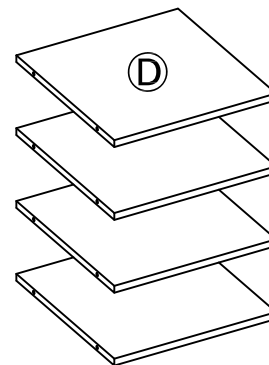

Partition board
(Qty: 4)

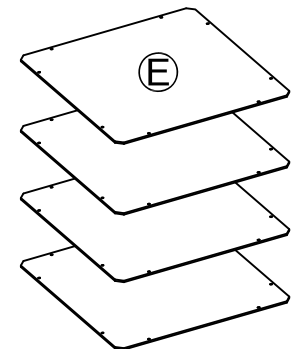

Back panel
(Qty: 4)

VERIFY THAT ALL PARTS ARE LISTED BEFORE BEGINNING



We are available to assist you Monday -Friday
from 9:00 am - 5:00 pm Eastern Standard Time.
1-800-729-1569
USA only.

MAINSTAYS 8-CUBE ORGANIZER

VENDOR STOCK NUMBERS
 MS18-D1-1009-51-RUSTIC BROWN
 MS18-D1-1009-52-CANYON WALNUT

cm

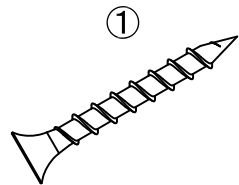
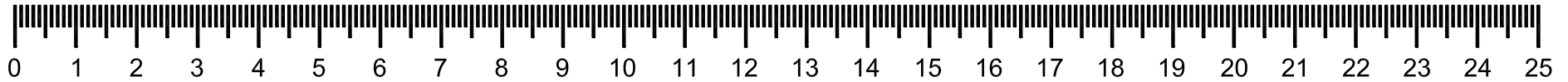

Screw
Qty: 20

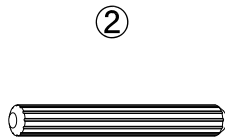

Plastic dowel 1 (short)
Qty: 14



Plastic dowel 2 (long)
Qty: 6

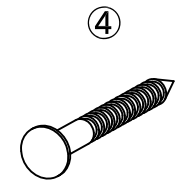

Nail
Qty: 32+2 Extra

inch

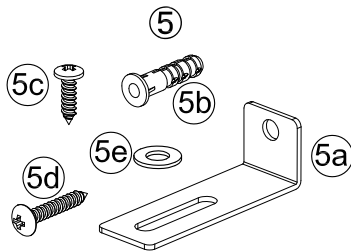

Safety mounting hardware
Qty: 1



Cap
Qty: 20+1 Extra



Nail holder
Qty: 1

VERIFY THAT ALL PARTS ARE LISTED BEFORE BEGINNING



We are available to assist you Monday -Friday
 from 9:00 am - 5:00 pm Eastern Standard Time.
1-800-729-1569
 USA only.

1

Insert part ② (short plastic dowel) into all A & C panels and 2 of the D panels.

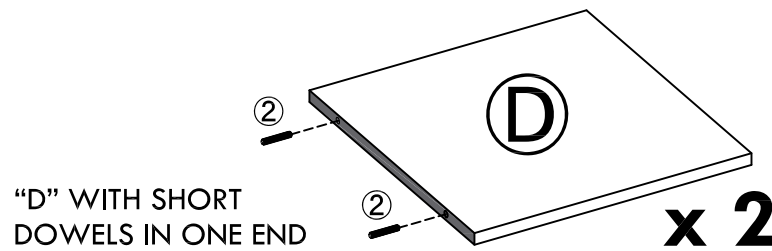
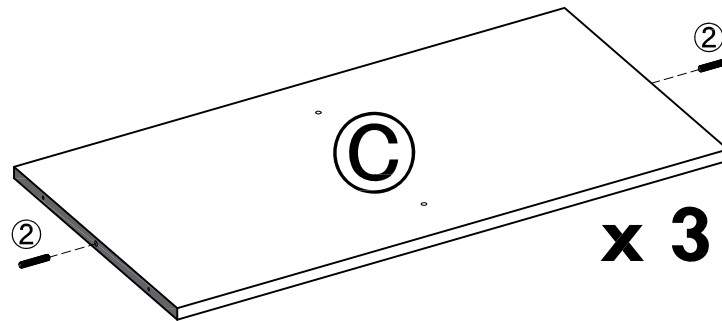
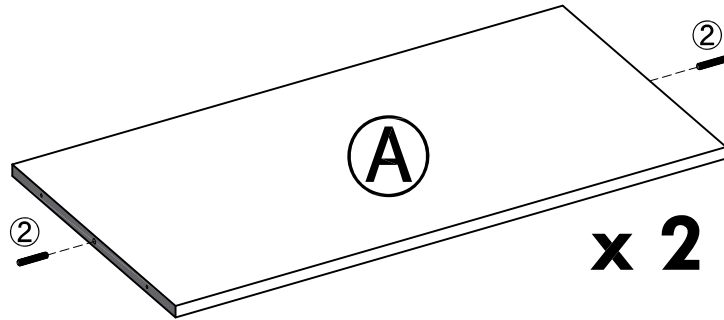

ADDITIONAL NOTES

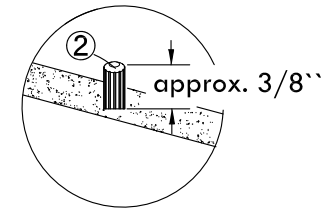

PARTS

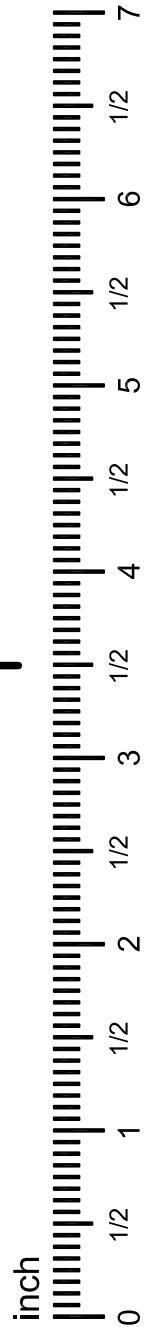
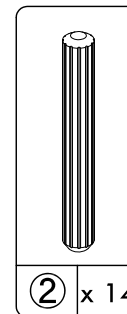

2

In one D panel insert part ③ (long plastic dowel)-2 in both ends.
In last D panel insert part ③ (long plastic dowel)-2 in only one end.

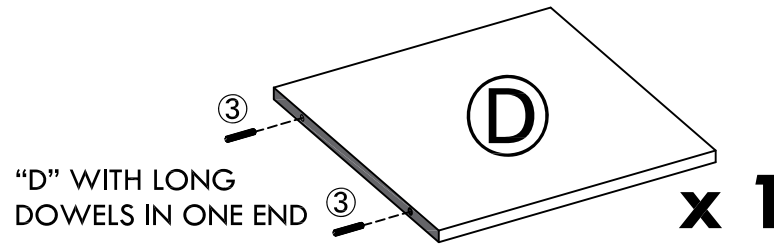
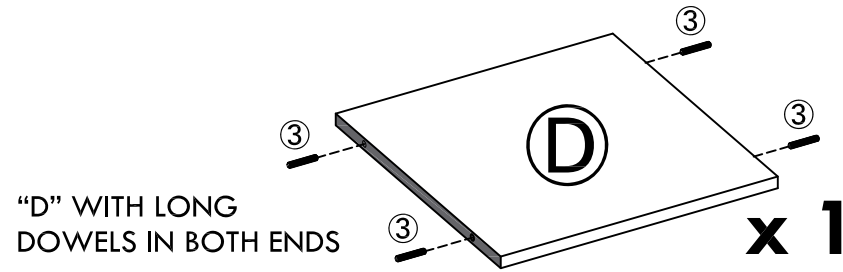

ADDITIONAL NOTES

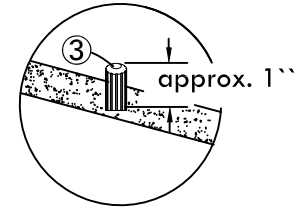

PARTS

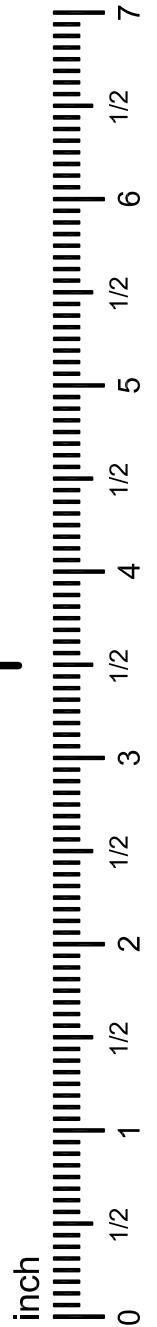
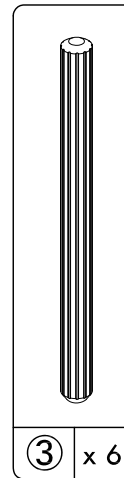

3

Align D panels between A and C panels as shown below.

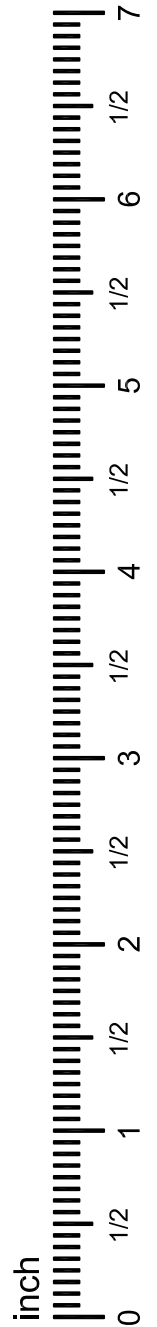
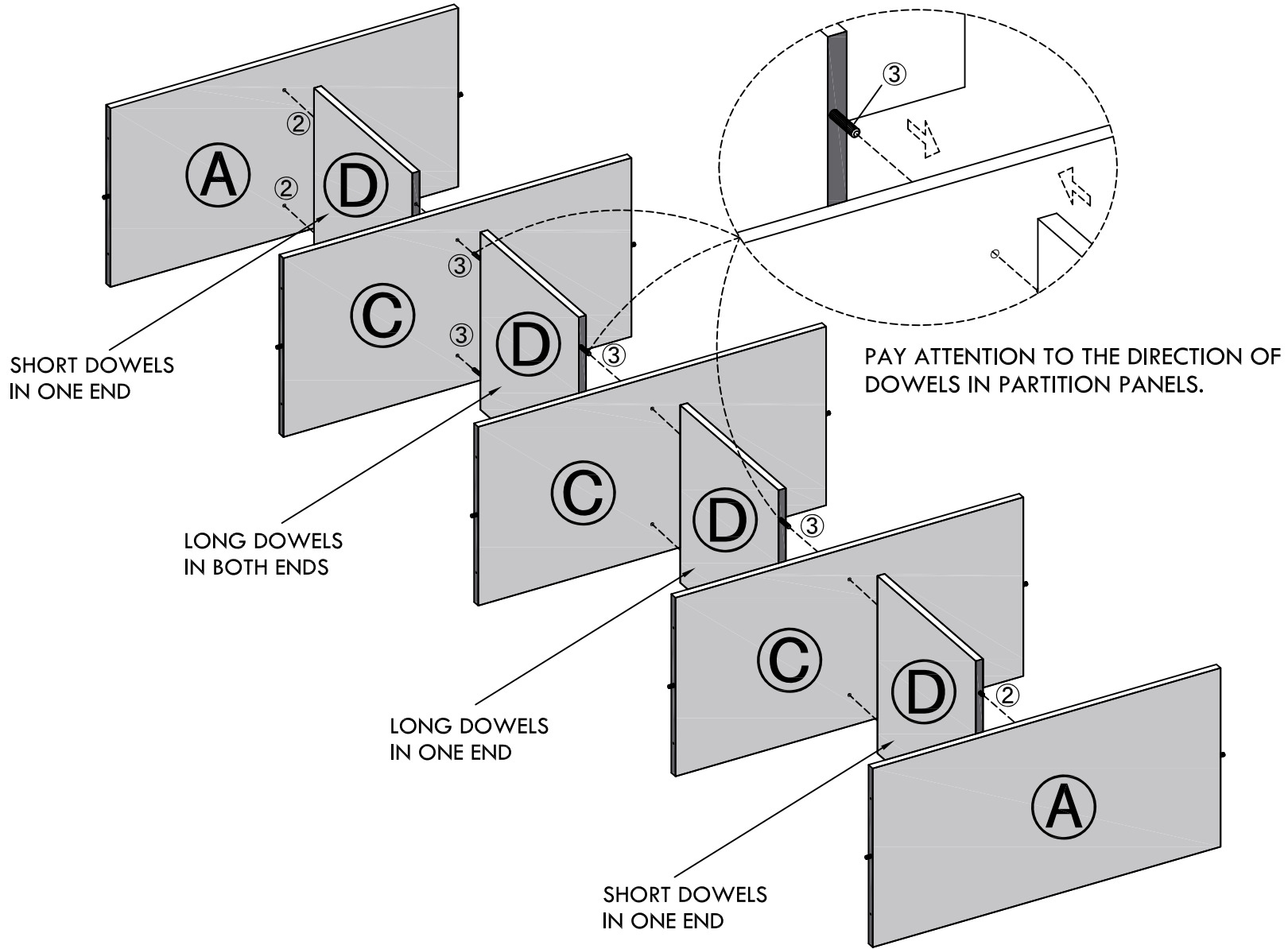

4

Attach B panels to structure using part ① (screws).
Cover exposed screw heads in B panels with part ⑥ (caps).

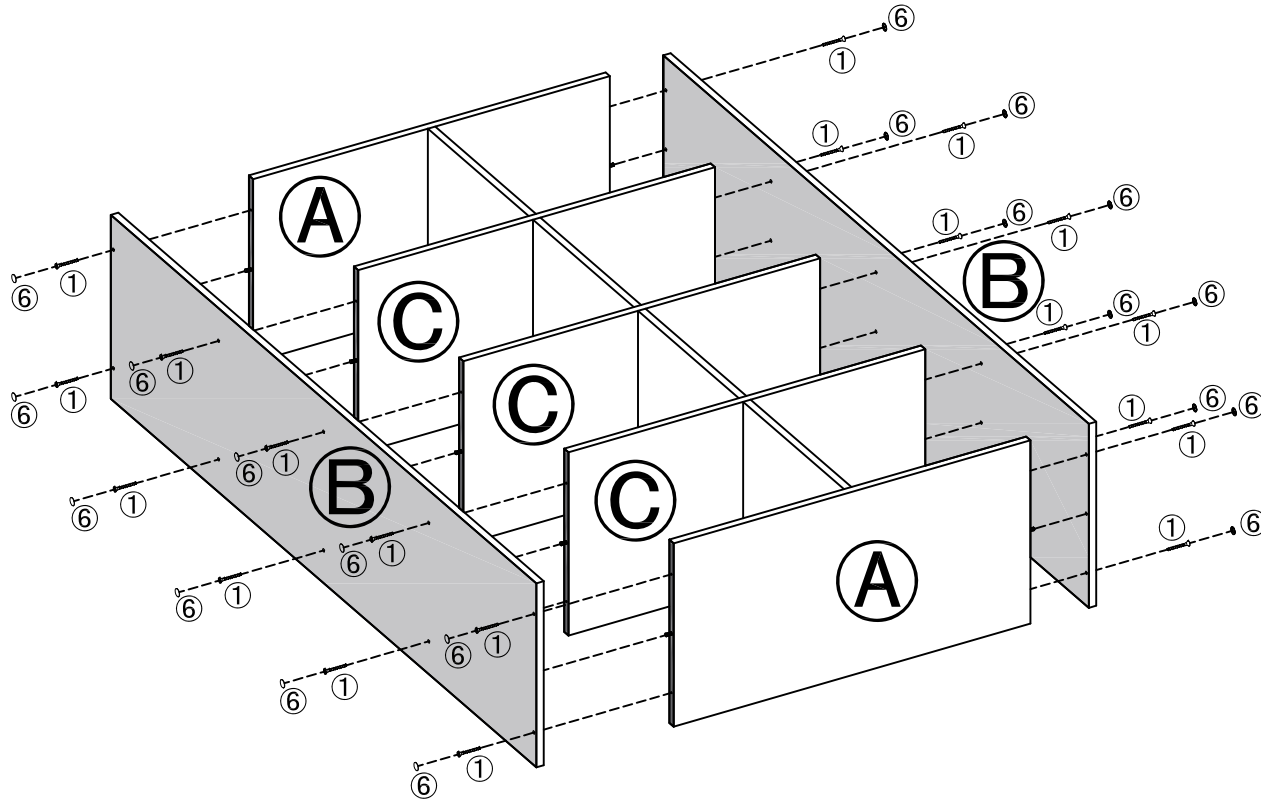

CAUTION: Back panels must be attached before moving or using unit.
Failure to attach back panels will result in instability.

ADDITIONAL NOTES

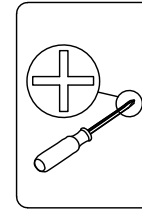

PARTS

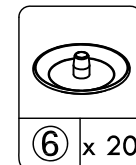
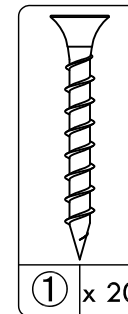

inch



5

Align and attach back panels E to unit using part ④ (nails) and part ⑦ (nail holder).

ADDITIONAL NOTES

Place nail in nail holder and slide holder up to the side of the unit until flush. The nail will be centered in the particle board. Hammer nail slightly into the board, then slide nail holder off and finish hammering in nail.

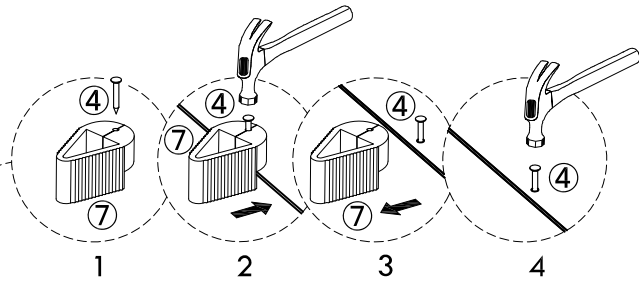
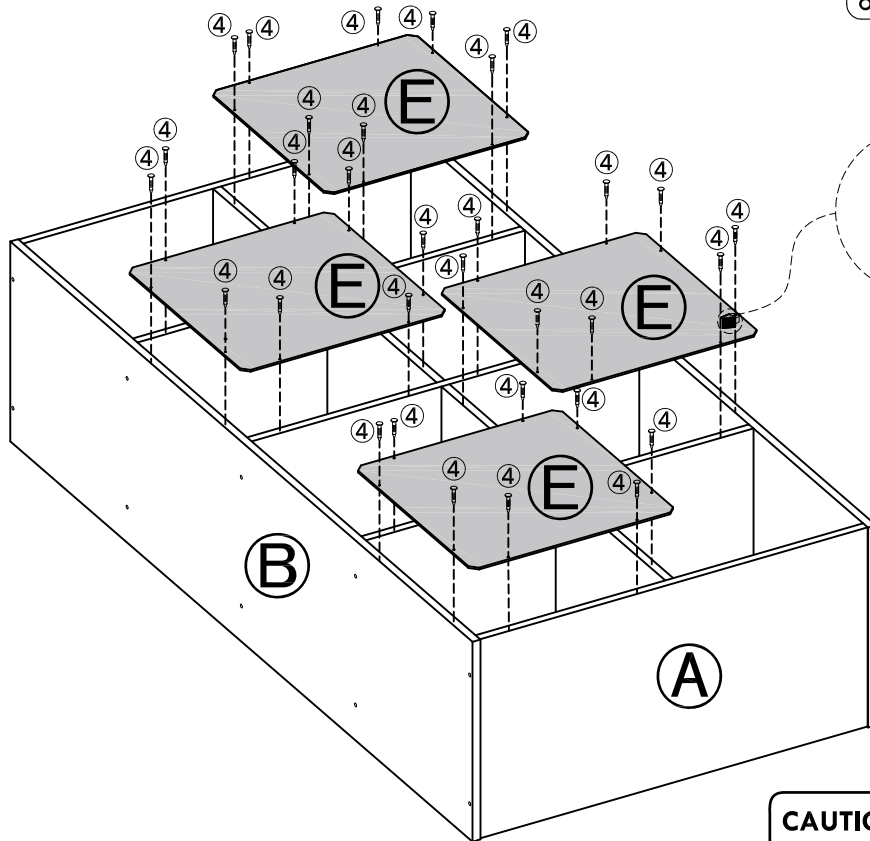

CAUTION: Back panels must be attached before moving or using unit. Failure to attach back panels will result in instability.

ADDITIONAL NOTES

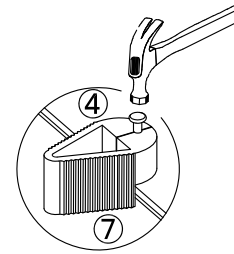

PARTS

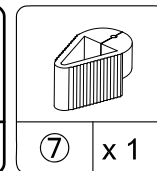
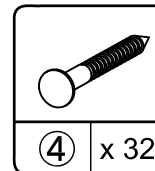

inch



6



WARNING



- This product is not designed as a free standing unit.
- For safety and stability, this product must be secured to a wall with the included mounting hardware.

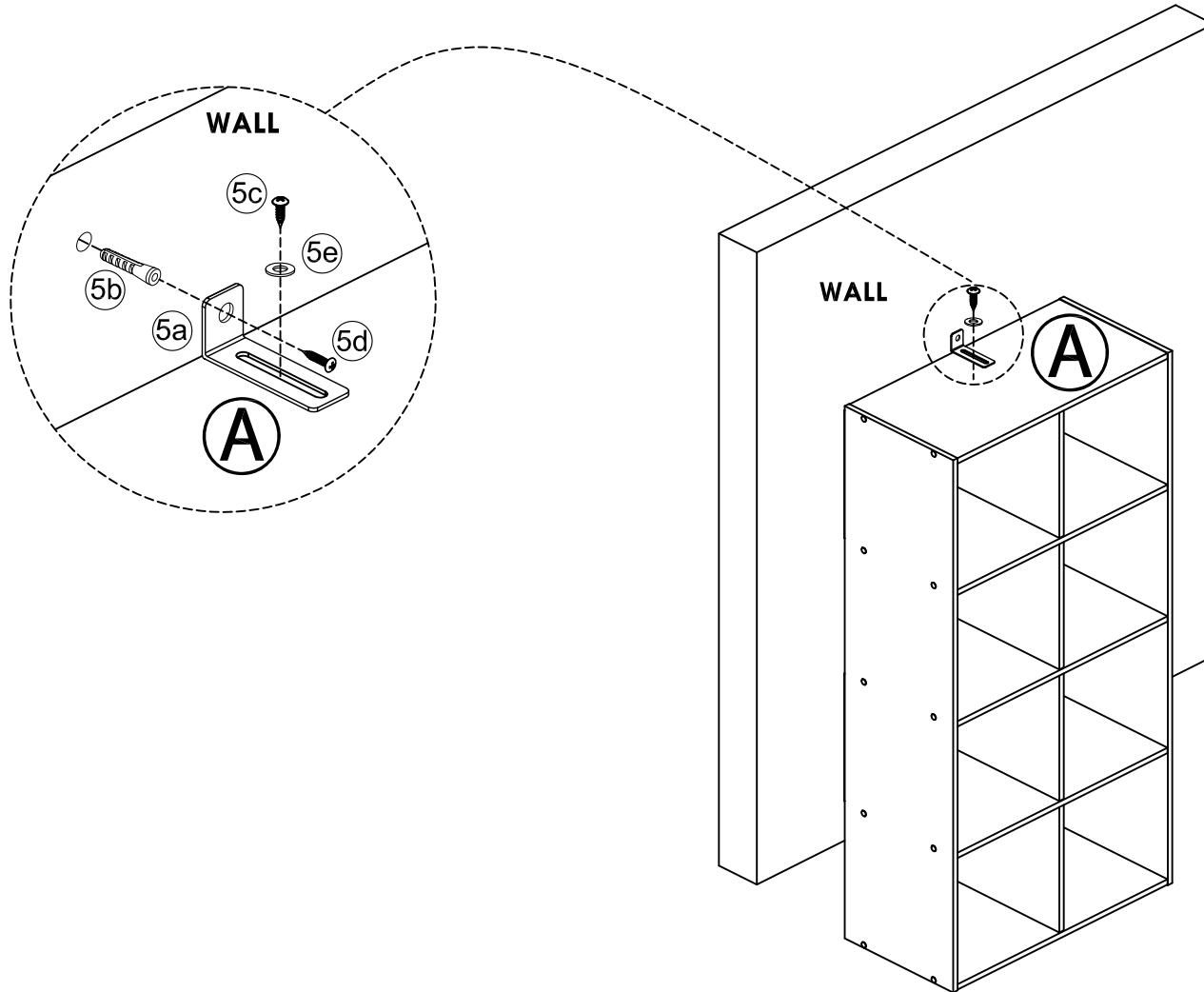

ADDITIONAL NOTES

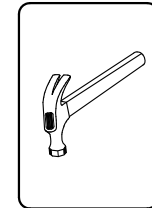
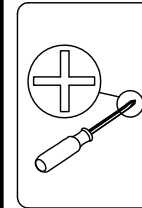

PARTS

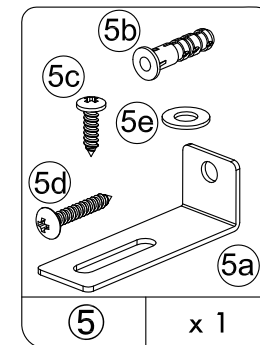

inch



Now Your Unit Is Completed

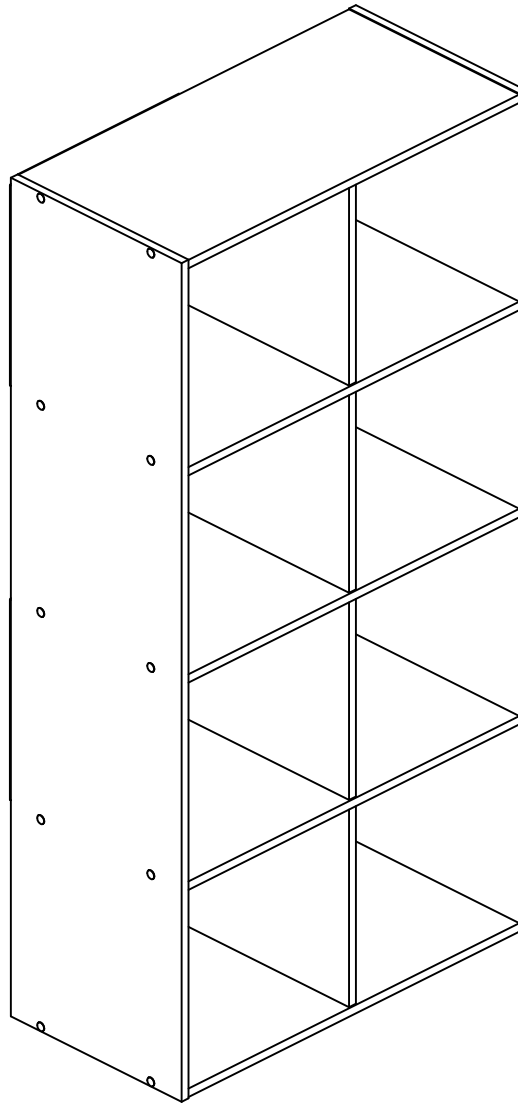

**Please call for replacement parts or assistance: 1-800-729-1569
Monday - Friday 9:00 am - 5:00 pm EST**

MAINSTAYS ORGANIZADOR DE 8 CUBOS

NÚMERO DE STOCK DEL VENDEDOR
MS18-D1-1009-51-MARRÓN RÚSTICO
MS18-D1-1009-52-CAÑÓN DE NOGAL

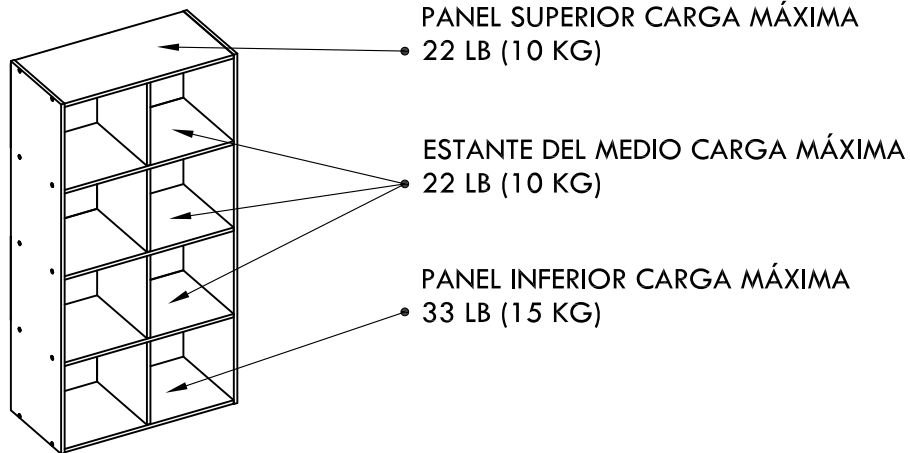

NÚMERO DE PERSONAS RECOMENDADO PARA EL ENSAMBLAJE: 1
TIEMPO ESTIMADO DE ENSAMBLAJE: 1 HORA

- LLAME A NUESTRO NÚMERO GRATUITO **1-800-729-1569** PARA OBTENER MÁS AYUDA.
- PIEZAS ADICIONALES ESTÁN DISPONIBLES POR UNA TARIFA.
- ESTE MANUAL DE INSTRUCCIÓN CONTIENE INFORMACIÓN **IMPORTANTE** DE SEGURIDAD. POR FAVOR DE LEER Y GUARDAR PARA FUTURAS REFERENCIAS.
- NO DEJAR A LOS NIÑOS SUBIR O JUGAR SOBRE LA UNIDAD.
- LIMPIAR EL PRODUCTO CON TU PULIDOR FAVORITE DE MUEBLE Y UN TRAPO BLANDO.
- NO USAR QUÍMICOS FUERTES O PRODUCTO DE LIMPIEZA ABRASIVO.
- MUEVA SUS NUEVOS MUEBLES CUIDADOSAMENTE CON DOS PERSONAS, NUNCA EMPUJE O ARRASTRE LA UNIDAD.

NO DEVOLVER EL PRODUCTO A LA TIENDA. TIENDAS INDIVIDUALES NO RESERVAN PIEZAS. PARA PIEZAS PERDIDAS O DAÑADAS LLAME AL 1-800-729-1569. PARTES SERÁN ENVIADOS DE FORMA GRATUITA. PARA UN SERVICIO RÁPIDO Y CONFIABLE, POR FAVOR DE TENER A MANO EL MANUAL DE ENSAMBLAJE.

NÚMERO DE PARTIDA _____
FECHA DE COMPRA ___/___/___

Huisen Furniture (Longnan) Co.,Ltd.
Diseñado en el E.E.U.U.
Hecho en China



Estamos disponibles para ayudarlo de Lunes - Viernes de 9:00 am - 5:00 pm Hora de la Zona Este.
1-800-729-1569
Sólo E.E.U.U.

MAINSTAYS ORGANIZADOR DE 8 CUBOS

NÚMERO DE STOCK DEL VENDEDOR
MS18-D1-1009-51-MARRÓN RÚSTICO
MS18-D1-1009-52-CAÑÓN DE NOGAL



ANTES DE COMENZAR

- Leer y entender todos los pasos cuidadosamente antes de comenzar. Si no se sigue cada paso en el orden correcto, el montaje será difícil y puede ocasionar daños.
- Trabajar en una zona amplia, mejor sobre la alfombra, cerca del sitio donde la unidad se utiliza.
- Asegurarse de que todas las piezas estén incluidos. La mayoría de los tableros están etiquetados con una pegatina removible.

Consejos útiles

- Llamar a nuestro número gratis para ayuda. Estamos disponibles para ayudarlo de lunes - Viernes de 9:00 am - 5:00 pm hora de la zona este.
- **1-800-729-1569** Sólo E.E.U.U.
O haga una solicitud a través de nuestro portal de autoservicio en www.huisenfurniture.zendesk.com

HERRAMIENTAS NECESARIAS PARA ENSAMBLAR

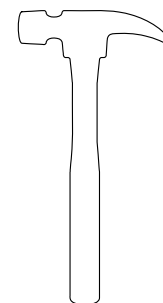

martillo



**destornillador de
cabeza phillips**



**NO UTILICE HERRAMIENTAS ELÉCTRICAS
PARA MONTAR SUS MUEBLES.
HERRAMIENTAS ELÉCTRICAS PUEDEN
DAÑAR LAS PIEZAS Y PROVOCAR DAÑOS.**

Huisen Furniture (Longnan) Co.,Ltd.
Diseñado en el E.E.U.U.
Hecho en China



Estamos disponibles para ayudarlo de Lunes - Viernes
de 9:00 am - 5:00 pm Hora de la Zona Este.
1-800-729-1569
Sólo E.E.U.U.

MAINSTAYS ORGANIZADOR DE 8 CUBOS

NÚMERO DE STOCK DEL VENDEDOR
MS18-D1-1009-51-MARRÓN RÚSTICO
MS18-D1-1009-52-CAÑÓN DE NOGAL

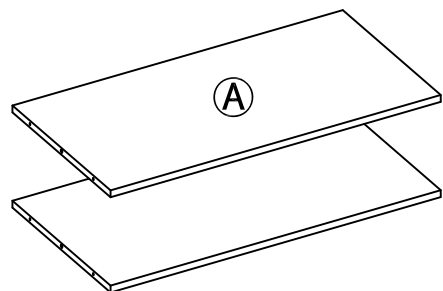

Panel superior/inferior
(Cantidad: 2)

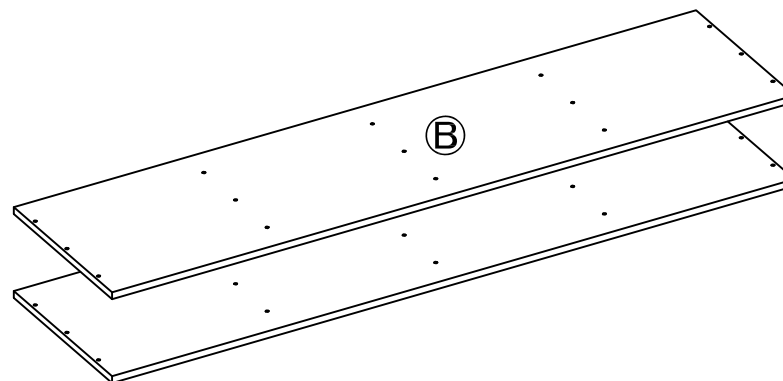

Panel lateral
(Cantidad: 2)

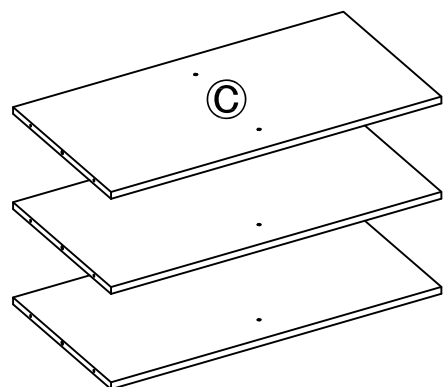

Estante del medio
(Cantidad: 3)



Tabla de tabique
(Cantidad: 4)



Panel posterior
(Cantidad: 4)

VERIFIQUE QUE TODAS LAS PIEZAS ESTÉN EN LA LISTA ANTES DE COMENZAR

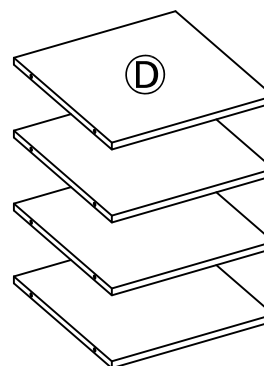
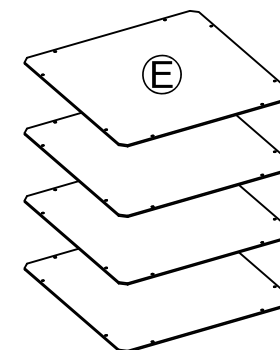

Estamos disponibles para ayudarlo de Lunes - Viernes de 9:00 am - 5:00 pm Hora de la Zona Este.
1-800-729-1569
Sólo E.E.U.U.

MAINSTAYS ORGANIZADOR DE 8 CUBOS

NÚMERO DE STOCK DEL VENDEDOR
MS18-D1-1009-51-MARRÓN RÚSTICO
MS18-D1-1009-52-CAÑÓN DE NOGAL

cm

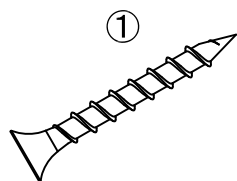
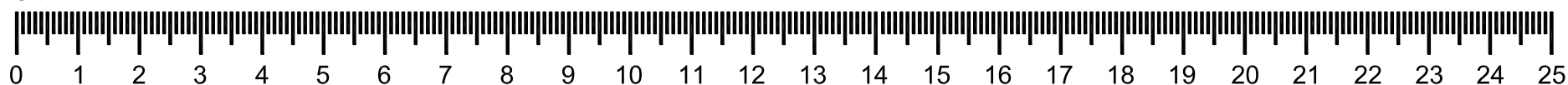

Tornillo
Cantidad: 20



Clavija de plástico 1 (corto)
Cantidad: 14



Clavija de plástico 2 (largo)
Cantidad: 6

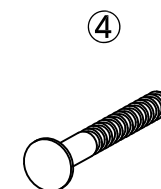

Clavo
Cantidad: 32+2 Extra

inch

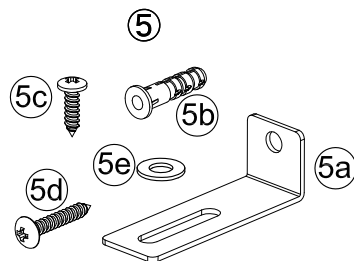
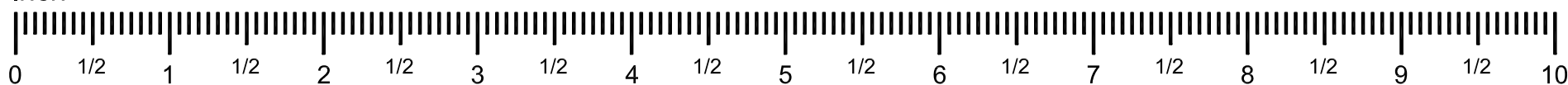

Accesorios de montaje
Cantidad: 1



Tapón
Cantidad: 20+1 Extra



Soporte de clavo
Cantidad: 1

VERIFIQUE QUE TODAS LAS PIEZAS ESTÉN EN LA LISTA ANTES DE COMENZAR



Estamos disponibles para ayudarlo de Lunes - Viernes de 9:00 am - 5:00 pm Hora de la Zona Este.
1-800-729-1569
Sólo E.E.U.U.

1

Inserte la parte ② (clavija corto plástico) en todos los A y C paneles y en 2 de los D paneles .

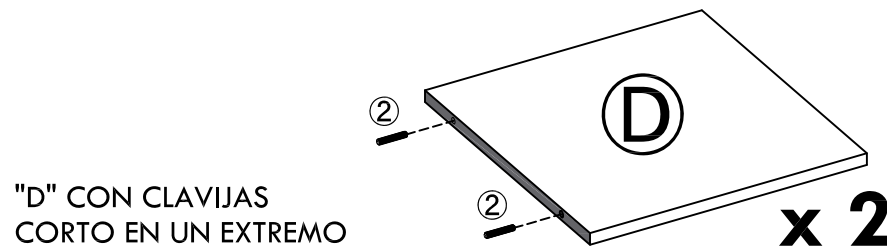
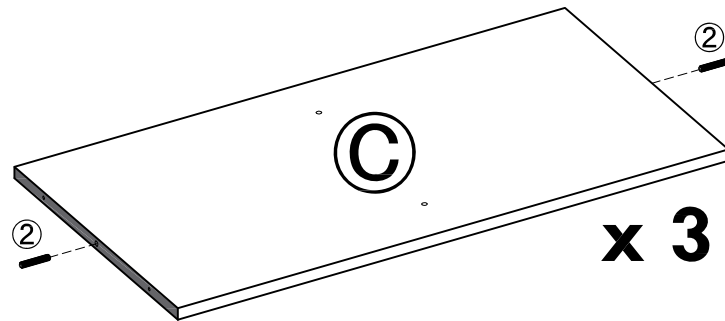
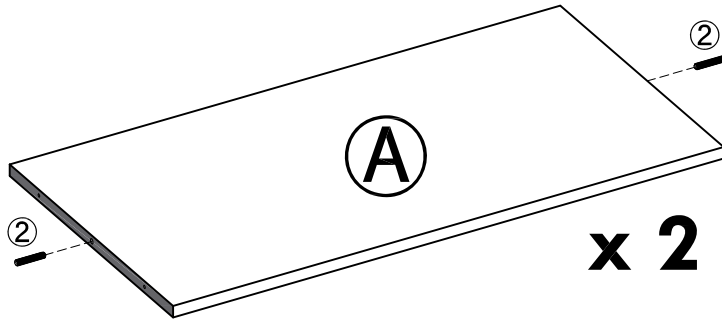

NOTAS ADICIONALES

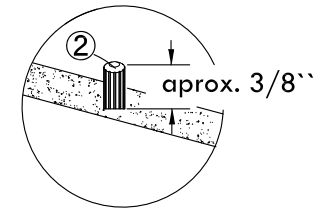

PARTES

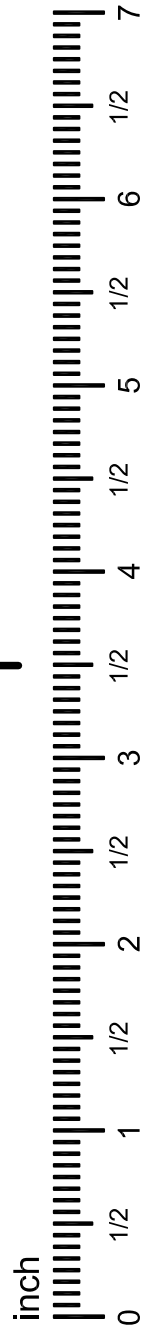
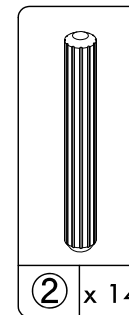

2

En uno de los D panel inserte la parte ③ (clavija largo plástico)-2 en ambos extremos.
En el último D panel inserte la parte ③ (clavija largo plástico)-2 en un solo extremo.

"D" CON CLAVIJAS
LARGO EN AMBOS EXTREMOS

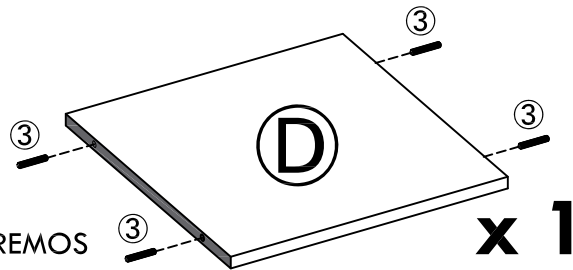

"D" CON CLAVIJAS
LARGO EN UN EXTREMO

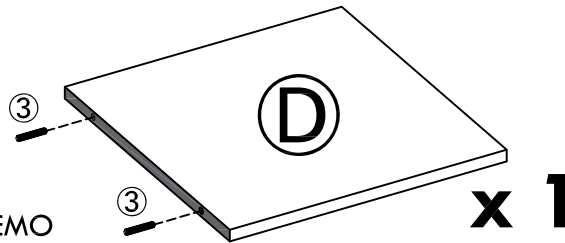

NOTAS ADICIONALES

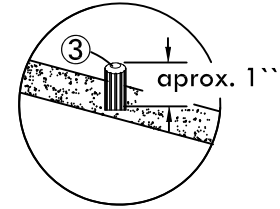

PARTES

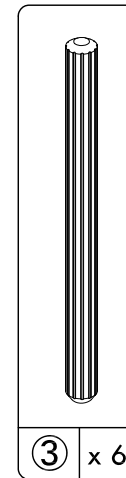

inch



3

Alínea los D paneles entre los A y C paneles como se muestra.

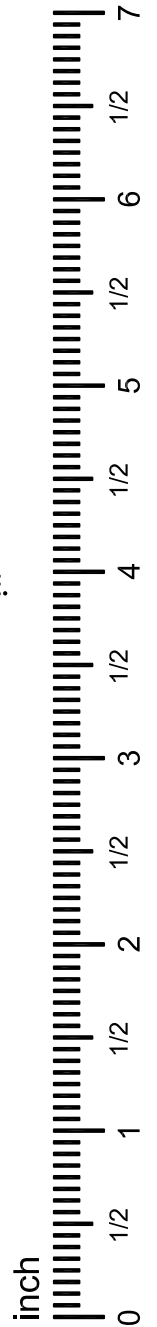
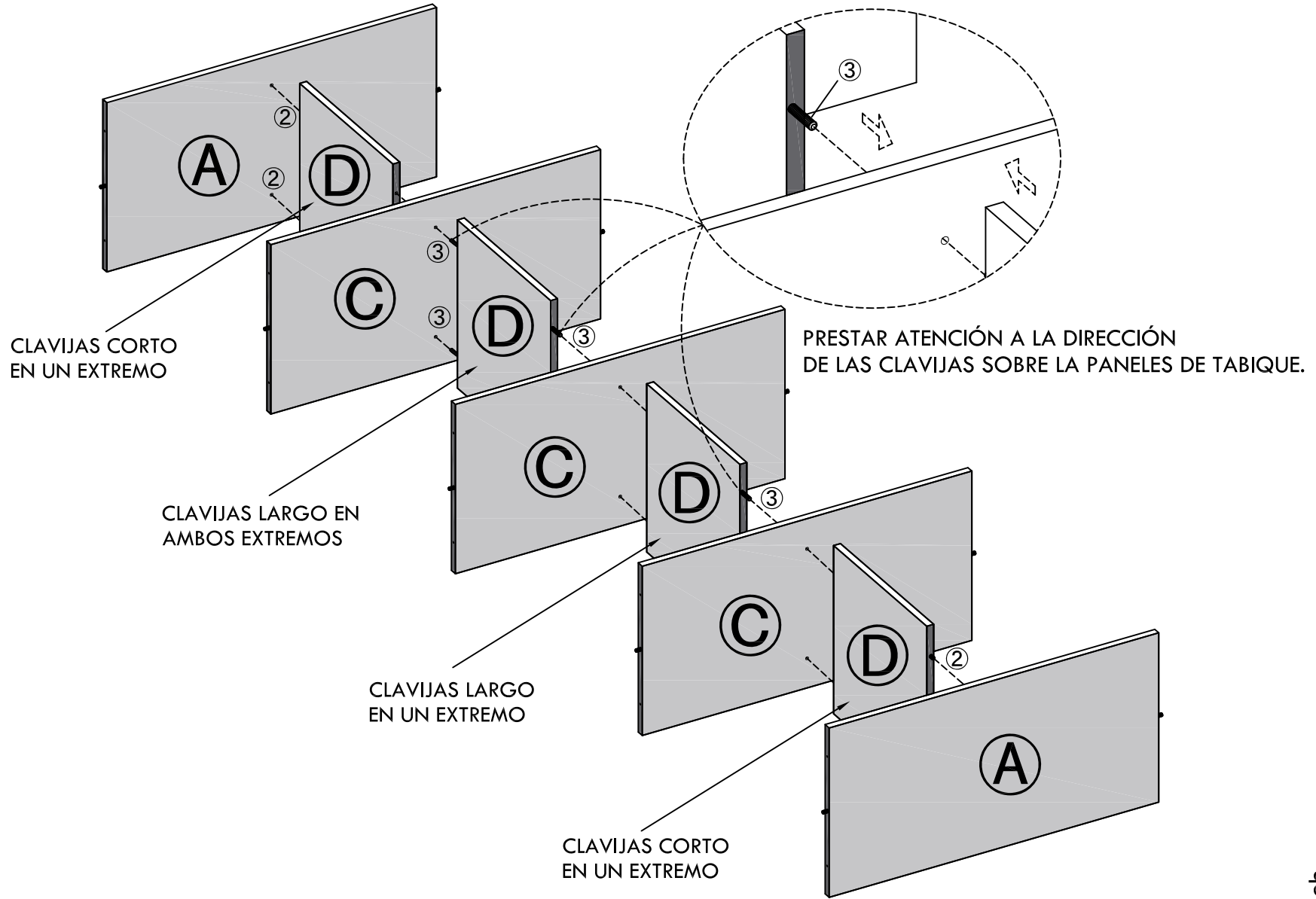

4

Adjuntar B paneles a la estructura usando el parte ① (tornillos).
 Utilice parte ⑥ (tapón) para cubrir los cabeza del tornillo expuestos en el B paneles.

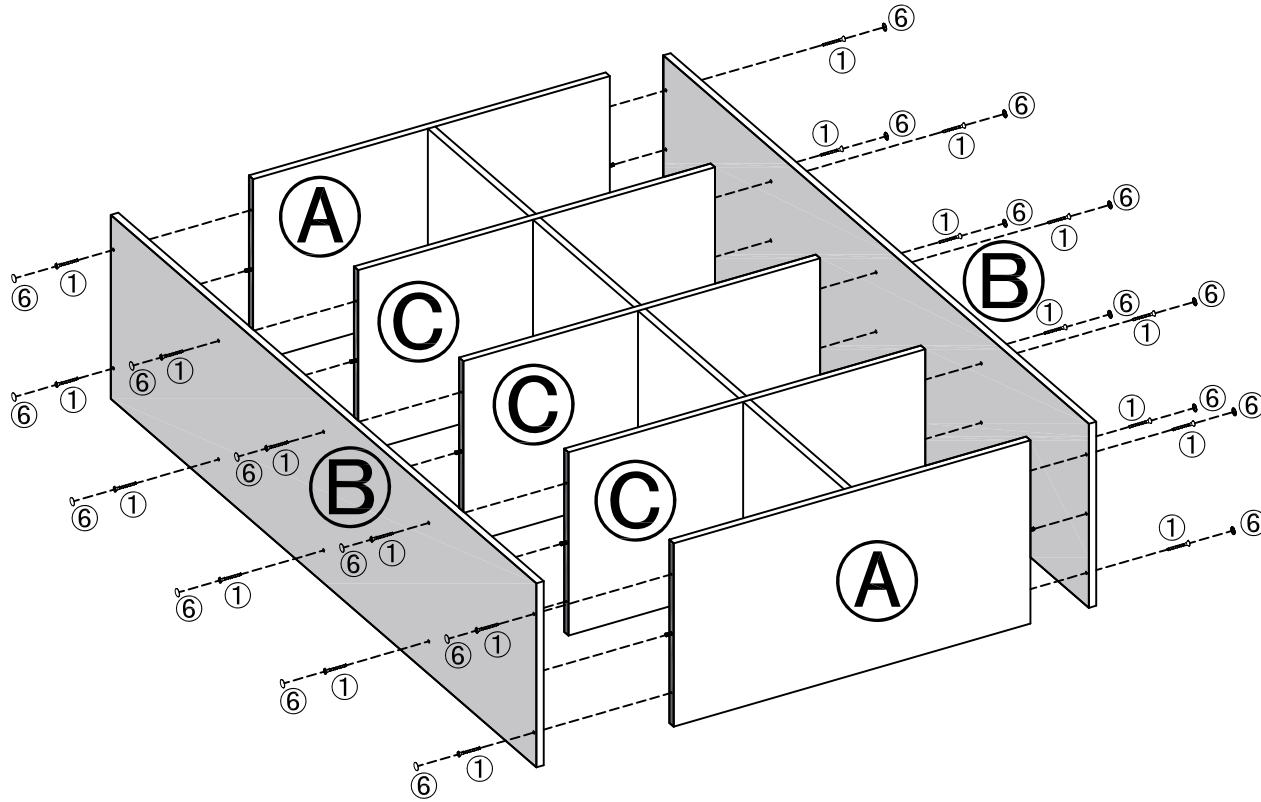

PRECAUCIÓN: Los paneles traseros deben fijarse antes de mover o utilizar la unidad.
 El fallo de fijarse los paneles traseros resultará en inestabilidad.

NOTAS ADICIONALES

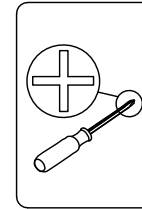

PARTES

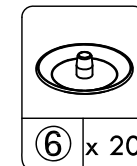
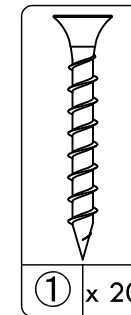

inch



5

Alinee y adjuntar el paneles posterior E a la unidad usando el parte ④ (clavos) y parte ⑦ (soporte de clavo).

NOTAS ADICIONALES

Coloque un clavo en el soporte de clavos y deslice el soporte hacia el borde de la unidad hasta que quede al ras. El clavo se colocará en el centro del tablero de partículas. Martille el clavo ligeramente en el tablero, luego deslice el soporte hacia atrás y martille el resto de clavo.

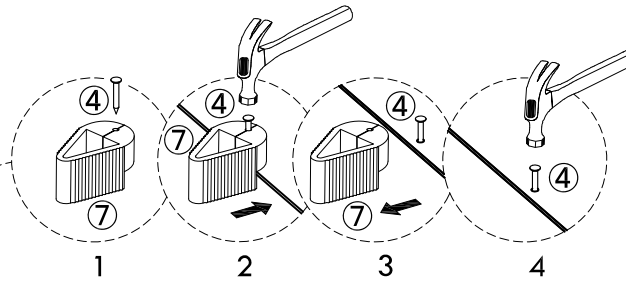
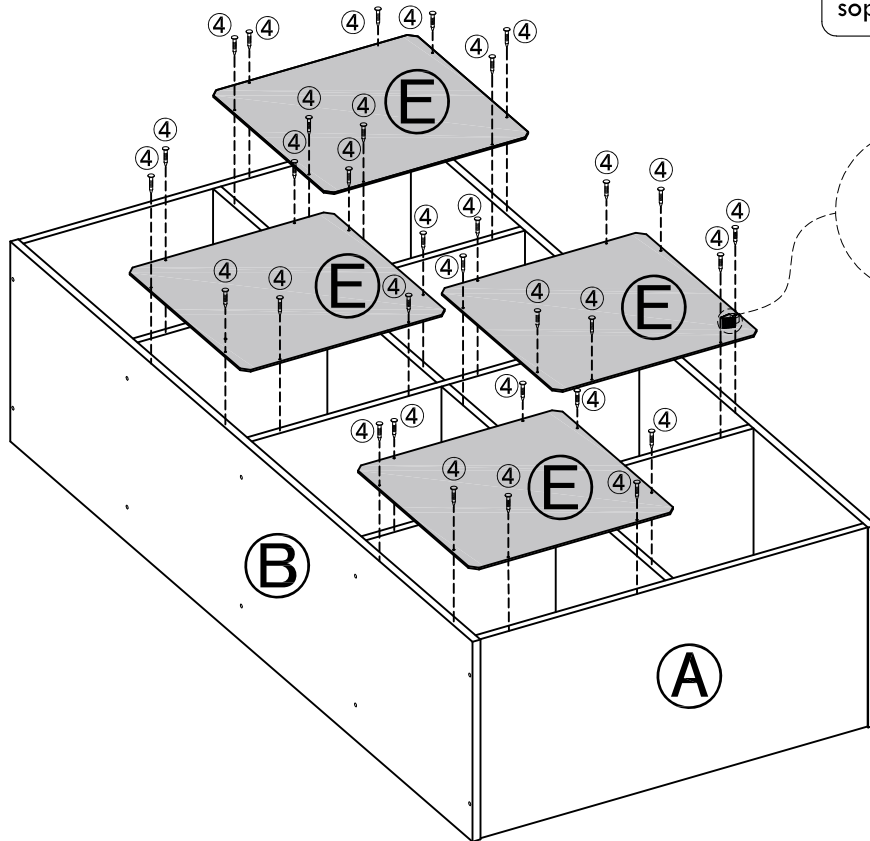

PRECAUCIÓN: Los paneles traseros deben fijarse antes de mover o utilizar la unidad. El fallo de fijarse los paneles traseros resultará en inestabilidad.

NOTAS ADICIONALES

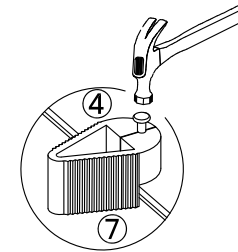

PARTES

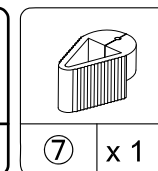
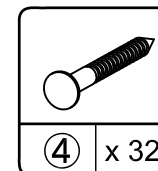

inch



6



ADVERTENCIA



- El producto no está diseñado como unidad estable.
- Por su seguridad y estabilidad, asegúrese de que esté sujeto en la pared con los accesorios de montaje.

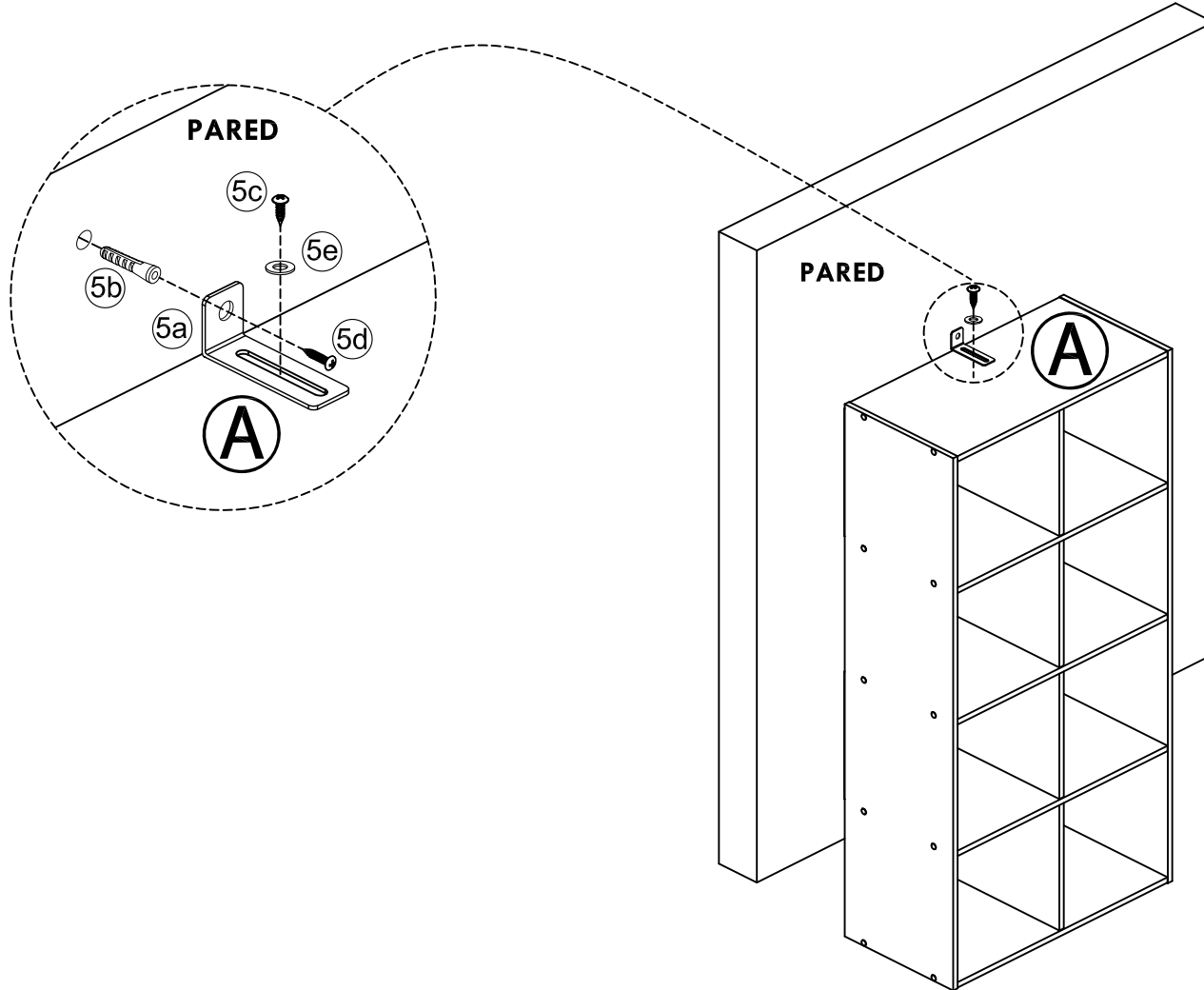

NOTAS ADICIONALES

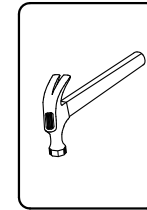
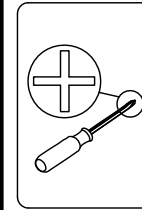

PARTES

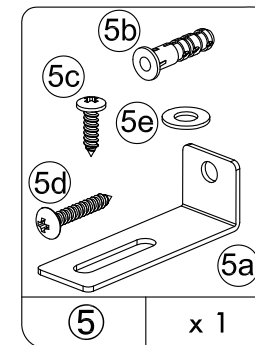

inch



Ahora Tu Unidad Está Compuesta

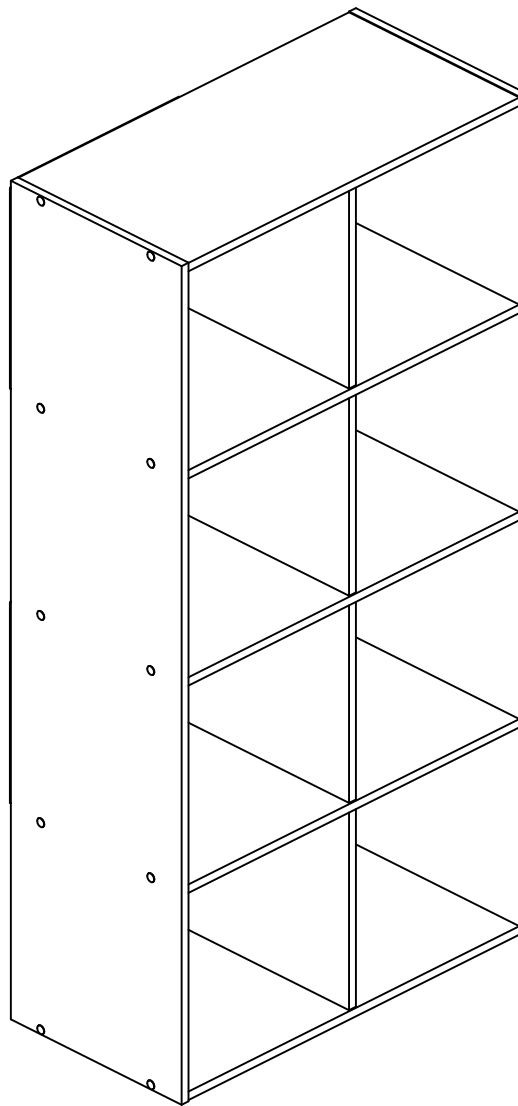

Por favor de llamarnos para piezas de reemplazo o ayudas: 1-800-729-1569
Lunes - Viernes 9:00 am - 5:00 pm EST